



NEWPORT COAST

Local Coastal Program Second Amendment

December 3, 1996

Certified Document



NEWPORT COAST

Local Coastal Program Second Amendment

December 3, 1996



15079
31

NEWPORT COAST

NEWPORT COAST

LOCAL COASTAL PROGRAM

Second Amendment

Approved by the Orange County Planning Commission
on May 21, 1996, Resolution No. 96-04.

Approved by the Orange County Board of Supervisors
on July 16, 1996, Resolution No. 96-529.

Submitted to the California Coastal Commission
on August 6, 1996.

Approved by the California Coastal Commission
on October 10, 1996.

Certified by the Orange County Board of Supervisors
on December 3, 1996, Resolution No. 96-861
and Ordinance No. 096-3974.

Certified by the California Coastal Commission
on January 21, 1997.

CONTENTS

<u>INTRODUCTION: LOCAL AND REGIONAL SETTING</u>	<u>PAGE</u>
1. PURPOSE AND INTENT	1
2. AREA DESCRIPTION	3
3. RESOURCE DESCRIPTION	4
4. REGIONAL OPEN SPACE SETTING	8
<u>PART I: LAND USE PLAN</u>	
1. MAIN ELEMENTS OF THE LAND USE PLAN	I-1.1
A. <u>Open Space</u>	
B. <u>Tourist Commercial</u>	
C. <u>Golf Courses/Greenbelt</u>	
D. <u>Residential</u>	
E. <u>Circulation</u>	
F. <u>Public Works/Infrastructure</u>	
2. COASTAL ACT CONSISTENCY AND OVERALL FINDINGS AND CONCLUSIONS	I-2.1
A. <u>Resources Protection Program</u>	
1. Open Space Dedication Programs	
2. Environmentally Sensitive Habitat Areas	
3. Riparian Habitat Creation Program	
4. Erosion Control and Urban Runoff	
5. Visual Quality	
a. Views from PCH toward the Ocean	
b. Views from the Moro Ridge Area of Crystal Cove State Park	
c. Views Inland from PCH and the Coastal Shelf	
d. Views from Newport Coast Drive	

CONTENTS

(Continued)

<u>PART I: LAND USE PLAN</u> (Continued)	<u>PAGE</u>
B. <u>Development Policies</u>	
1. Tourist Commercial	
a. Visitor-Serving Functions	
b. Location of Visitor-Serving Uses	
c. A Destination Resort	
d. Enhancement of Inland Views	
e. Traffic Benefits Deriving from Visitor-Support Facilities	
2. Public Access	
3. Residential Uses	
4. Circulation	
3. RESOURCE CONSERVATION AND MANAGEMENT POLICIES	I-3.1
A. <u>Dedication Program Requirements and Procedures</u>	
1. Wilderness Open Space	
2. Special Use Open Space	
B. <u>Interim Conservation Management Policies</u>	
C. <u>Recreation/Open Space Management Policies</u>	
1. Irvine Coast Wilderness Regional Park	
2. Buck Gully, Los Trancos/Muddy Canyons, and Pelican Hill Areas	
D. <u>Category "A" & "B" ESHA Policies</u>	
E. <u>Category "C" ESHA Policies</u>	
F. <u>Category "D" ESHA Policies</u>	
G. <u>Archaeological Policies</u>	
H. <u>Paleontological Policies</u>	
I. <u>Erosion Policies</u>	
J. <u>Sediment Policies</u>	
K. <u>Runoff Policies</u>	
L. <u>Grading Policies</u>	
M. <u>Development/Open Space Edges Policies</u>	

CONTENTS

(Continued)

4. DEVELOPMENT POLICIES	I-4.1
A. <u>Tourist Commercial Policies</u>	
B. <u>Golf Course Policies</u>	
C. <u>Recreation/Public Access Policies</u>	
1. Laguna Canyon	
2. Planning Areas PA 12G and PA 20C	
D. <u>Residential Policies</u>	
E. <u>Transportation/Circulation Policies</u>	
F. <u>Public Works/Infrastructure Policies</u>	
PART II: <u>IMPLEMENTING ACTIONS PROGRAM —</u>	<u>PAGE</u>
<u>PLANNED COMMUNITY DISTRICT REGULATIONS</u>	
1. INTRODUCTION	II-1.1
2. PURPOSE AND OBJECTIVES	II-2.1
3. GENERAL PROVISIONS AND REGULATIONS	II-3.1
4. RESIDENTIAL PLANNING AREAS	II-4.1
5. TOURIST COMMERCIAL PLANNING AREAS	II-5.1
6. GOLF COURSE PLANNING AREAS	II-6.1
7. RECREATION PLANNING AREAS	II-7.1
8. CONSERVATION PLANNING AREAS	II-8.1
9. OFF-STREET PARKING REGULATIONS	II-9.1
10. DISCRETIONARY PERMITS AND PROCEDURES	II-10.1
11. DEVELOPMENT MAP AND STATISTICAL TABLE REGULATIONS AND PROCEDURES	II-11.1
12. DEFINITIONS	II-12.1
13. LEGAL DESCRIPTION	II-13.1

LIST OF EXHIBITS

<u>CODE</u>	<u>TITLE</u>	<u>PAGE</u>
A.	Location Map	2
B.	Topographic Features	5
C.	Visually Significant Lands	9
D.	Regional Open Space Concept	11
E.	Land Use Summary	I-1.2
F.	Land Use Plan - First Amendment	I-1.3*
G.	Newport Coast Open Space	I-1.5
H.	Environmentally Sensitive Habitat Areas	I-2.4
I.	Wilderness Dedication Area	I-3.3
J.	Pelican Hill Resort Height Zones	I-4.3
K.	Planning Area 6 Development Edge Treatment	I-4.16
L.	Newport Coast Drive Alignment	I-4.19*
M.	Newport Coast Drive - Typical Sections	I-4.20
N.	Pacific Coast Highway - Typical Sections	I-4.21
O.	Newport Coast Arterial Roadway Phasing Summary	I-4.23
P.	Residential Entry Road and Residential Streets - Typical Sections	I-4.24
Q.	Backbone Water Concept	I-4.30
R.	Backbone Sewer Concept	I-4.31
S.	Backbone Drainage Concept	I-4.32
T.	Planned Community (PC Statistical Summary)	II-1.2
U.	Planned Community (PC Zoning Map)	II-1.3
V.	Sub-Watershed Areas for Master Drainage and Runoff Management Plan	II-3.8
W.	Planned Community (PC Development Map)	II-11.2*
X.	Planned Community (PC Statistical Table)	II-11.3
Y.	Appeal Jurisdiction	II-12.2
Z.	Buildable Envelope	II-12.4

Note: * This page provides a facsimile of the plan or map located in pocket at back of document.

APPENDIX I

(Technical Documents Bound under Separate Cover)

1. "California Coastal Commission Findings for LUP Certification;"
November 4, 1981.
2. "Pelican Hill Drainage Habitats;" September, 1986.
3. "Resort Hotel Traffic Study;" December 29, 1986.
4. "Irvine Coastal Area Traffic Analysis;" February 23, 1987.
5. "Local Park Implementation Plan: Irvine Coast Local Coastal Program;" July 1987.
6. "Visual Analysis: The Irvine Coast Proposed Land Use Plan Amendment;" July, 1987.
7. "Scenic Highway Implementation Plan: Pacific Coast Highway Viewscape Corridor;"
July 1987.
8. "Potential Ecological Influences of the Irvine Coast Planned Community on the Adjacent
Marine Environment;" Richard F. Ford, Ph.D.; May 15, 1987.

1
2
3
4
5
6
7
8
9
10
11
12
13
14
15
16
17
18
19
20
21
22
23
24
25
26
27
28

**Resolution of the Board of Supervisors
Orange County, California**

December 3, 1996

On Motion of Supervisor Saltarelli, duly seconded and carried, the following Resolution was adopted.

WHEREAS, on July 16, 1996, this Board approved the Second Amendment to the Irvine (Newport) Coast Local Coastal Program (LCP) and refinements dated July 16, 1996, including the Implementing Actions Program, for purposes of submittal to the California Coastal Commission, pursuant to its Resolution No. 96-529; and

WHEREAS, on October 10, 1996, the California Coastal Commission considered the Second Amendment to the Irvine (Newport) Coast LCP; and

WHEREAS, the California Coastal Commission first denied certification of the Second Amendment to the Irvine (Newport) Coast LCP as submitted, and then identified recommended modifications to it which, if made, would result in certification of the modified Second Amendment to the Irvine (Newport) Coast LCP as being consistent with the California Coastal Act; and

WHEREAS, this Board has received and considered the modifications recommended by the California Coastal Commission for the Second Amendment to the Irvine (Newport) Coast LCP, and concurs in those modifications; and

WHEREAS, consistent with Resolution No. 96-529 The Irvine Company (Developer) has executed and provided to the County a copy of an agreement to mitigate the impacts of the project on the Laguna Beach Unified School District (LBUSD) substantially consistent with the terms specified in Resolution No. 96-529 permitting this Board to take final action on the Second Amendment to the Irvine (Newport) Coast LCP; and

WHEREAS, the Developer has consented to the adoption of the Second Amendment to the Irvine (Newport) Coast Local Coastal Program, including Zone Change ZC96-04, with the modifications recommended by the California Coastal Commission, as a "Future COUNTY Land Use Regulation" governing development of the project pursuant to the terms of paragraph 4.3.1 of the Irvine Coast Development Agreement, recorded in the Official Records of Orange County beginning on page 88-272903; and

WHEREAS, Section 21080.9, Division 13 of the Public Resources Code statutorily exempts the preparation and adoption of a Local Coastal Program and its amendment from California Environmental Quality Act (CEQA) requirements; and

WHEREAS, this Board has previously determined that as applied to development within the Irvine (Newport) Coast area, the General Plan makes adequate provision for library, sheriff, fire and paramedic protection, flood control improvements, open space and community parks; and

Resolution No. 96-861

1
2 WHEREAS, the Planning Commission conducted a duly noticed public
3 hearing on November 5, 1996, to consider a proposed Development Agreement
4 amendment and addendum PA950028 recognizing the Irvine (Newport) Coast LCP
- Second Amendment as the operative LCP for this area pursuant to
procedures established with respect to development agreements; and

5 WHEREAS, the proposed Development Agreement amendment will not
6 subject the County to any additional liability for monetary damages as a
7 result of any assurance or right contained therein or for any other
reason; and

8 NOW, THEREFORE, BE IT RESOLVED, that this Board reaffirms its July
9 16, 1996, action and grants final approval of the Second Amendment to the
10 Irvine (Newport) Coast Local Coastal Program, dated December 3, 1996,
which includes Zone Change ZC96-04 and the modifications recommended by
the California Coastal Commission, and adopts the same in accordance with
the declarations and findings contained in Board Resolution No. 96-529;
and

11 NOW, THEREFORE, BE IT FURTHER RESOLVED, that based upon the
12 foregoing recitals, which are incorporated herein as findings of this
13 Board, and the following findings, this Board hereby approves the First
Amendment to the Irvine (Newport) Coast Development Agreement to be
adopted by ordinance concurrently with this resolution:

14 1. The proposed project is covered by the following documents:
15 Orange County Final EIRs 485 and 486, certified on May 4, 1988 and April
16 20, 1988, respectively; City of Irvine FEIR 14539-GA, certified by the
17 City on March 28, 1995 and recertified by the Board of Supervisors on July
18 28, 1995; and Orange County Negative Declaration IP95-100 approved by the
19 Board of Supervisors on July 28, 1995 and the California Coastal
20 Commission's action on October 10, 1996 to certify the Irvine (Newport)
21 Coast Local Coastal Program - Second Amendment and accompanying CEQA
determinations pursuant to Public Resources Code Sections 21080.5 and
21080.9. Addendum PA950028, which was prepared for the Irvine (Newport)
Coast Development Agreement amendment, incorporates the previously
certified and approved CEQA documents for the project. Together, the
FEIRs, ND and Addendum serve as adequate CEQA documentation for the
proposed project and reflect the independent judgment of the Lead Agency.
Their Findings and Facts are hereby re-adopted.

22 2. The Development Agreement amendment is consistent with the
23 Orange County General Plan and applicable zoning regulations and
24 procedures since it incorporates the provisions of the Irvine Coast Local
Coastal Program and Land Use Regulations, all of which were found
consistent with the General Plan when adopted.

25 3. The Development Agreement amendment would maintain the
26 existing General Plan, the Irvine (Newport) Coast Planned Community
27 Development Plan and Land Use Regulations, and other selected ordinances,
28 during the build-out of the project, for the duration of the Agreement.
Nevertheless, the Development Agreement would ensure that the County's
future discretionary authority in reviewing and processing coastal
development permits, site development permits and subdivision maps will be
maintained.

Roger R. Stanton
Chairman of the Board of Supervisors

SIGNED AND CERTIFIED THAT A COPY
OF THIS DOCUMENT HAS BEEN DELIVERED
TO THE CHAIRMAN OF THE BOARD

Attest:

Darlene J. Bloom

DARLENE J. BLOOM
Clerk of the Board of Supervisors
of Orange County, California

AYES: SUPERVISORS DONALD J. SALTARELLI, JAMES W. SILVA, AND
ROGER R. STANTON

NOES: SUPERVISORS NONE

ABSENT: SUPERVISORS WILLIAM G. STEINER

STATE OF CALIFORNIA)
COUNTY OF ORANGE) ss.

I, DARLENE J. BLOOM, Clerk of the Board of Supervisors of Orange
County, California, hereby certify that the above and foregoing
Resolution was duly and regularly adopted by said Board at a regular
meeting thereof held on the 3rd day of December, 1996, and passed by a
unanimous vote of said Board members present.

IN WITNESS WHEREOF, I have hereunto set my hand and seal this 3rd
day of December, 1996.

Darlene J. Bloom
DARLENE J. BLOOM
Clerk of the Board of Supervisors
of Orange County, California

OFFICE OF
COUNTY CLERK
ORANGE COUNTY

J2-210 (5/77)

68

1
2
3
4
5
6
7
8
9
10
11
12
13
14
15
16
17
18
19
20
21
22
23
24
25
26
27
28

INTRODUCTION

LOCAL AND REGIONAL SETTING

1. PURPOSE AND INTENT

The Newport Coast Planned Community is a 9,493 acre parcel of land in the unincorporated territory of the County of Orange. The Planned Community is bordered on the north by the City of Newport Beach, on the east by the City of Irvine and unincorporated areas of the County of Orange, on the south by the City of Laguna Beach, and on the west by the Pacific Ocean.

The entire Planned Community is within the Coastal Zone as defined by the California Coastal Act of 1976 except for a relatively small sliver of Buck Gully (Recreation Planning Area 11A) along the community's northwestern edge. The Newport Coast Planned Community is therefore under the land use planning and regulatory jurisdiction of both the County of Orange and the California Coastal Commission.

The California Coastal Act of 1976 is incorporated in the California Public Resources Code. The Coastal Act provides for comprehensive planning of coastal areas. Local jurisdictions are required to prepare a Local Coastal Program (LCP) for those areas of their jurisdiction within the Coastal Zone. The LCP is composed of land use plans, zoning ordinances, and zoning regulations. After local adoption of the LCP and its certification by the Coastal Commission, the administration of the LCP is the responsibility of the local jurisdiction.

For purposes of developing and certifying an LCP, the coastal zone under the jurisdiction of the County of Orange is divided into separate geographical planning units. The Newport Coast Planned Community is coterminous with The Newport Coast Planning Unit of the Local Coastal Program of the County of Orange. (See Exhibit A.)

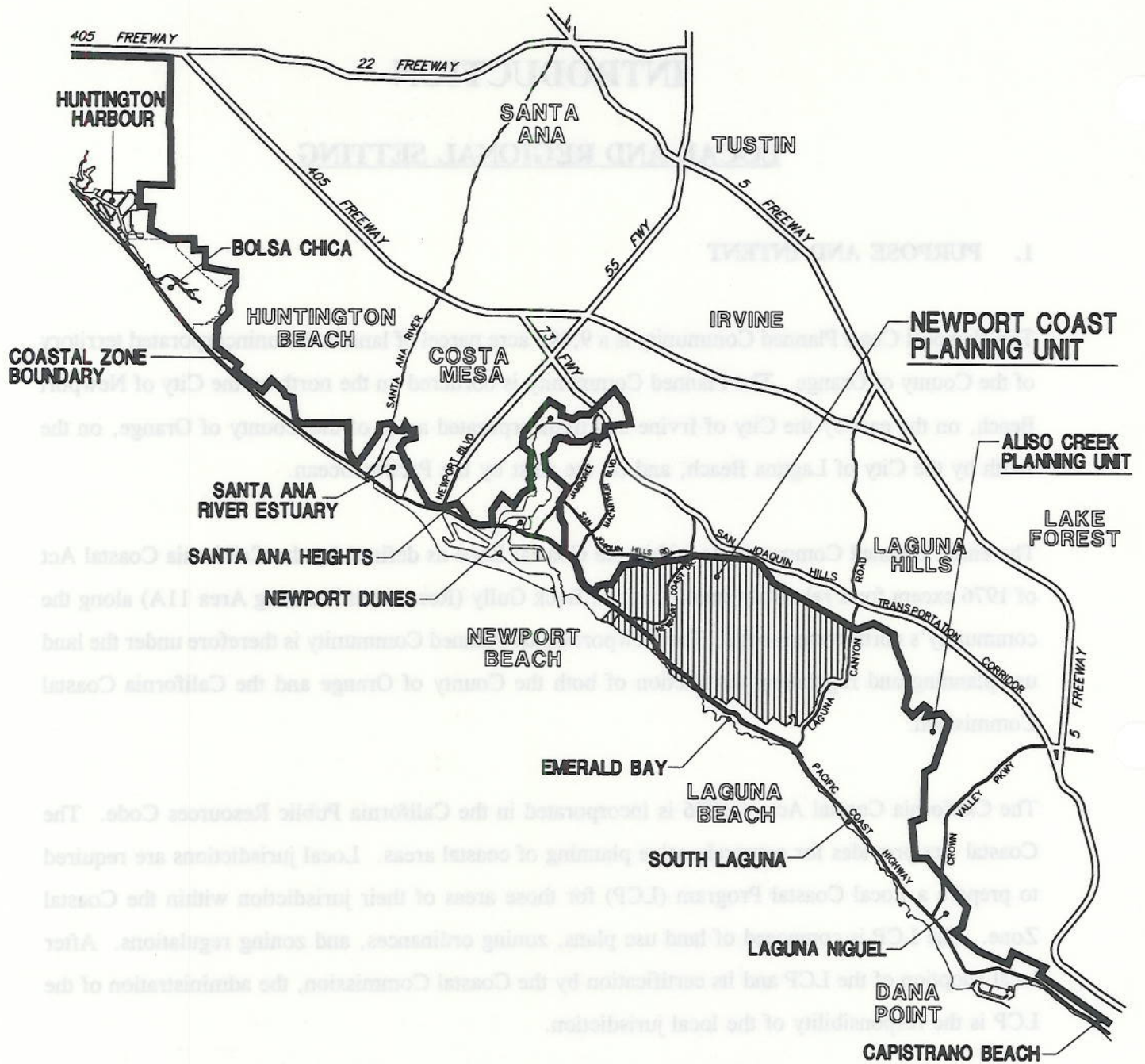

LOCATION MAP - Second Amendment

The Newport Coast Local Coastal Program

Exhibit A

NOT TO SCALE

December 3, 1996

The LCP is composed of a Land Use Plan (Part I), and an Implementing Actions Program -- Planned Community District Regulations (Part II). An Appendix to this LCP, containing technical documents identified in the table of contents (see page v) is bound separately. The Irvine Coast LCP Land Use Plan was originally certified by the California Coastal Commission on January 19, 1982; and the LCP First Amendment (Land Use Plan and Implementing Actions Program) was certified on January 14, 1988.

The Land Use Plan (LUP) is the general planning and policy component of the LCP. It illustrates the distribution of private and public open space, residential, and commercial uses; identifies the major road network; and sets the overall land use intensity. The Land Use Plan consists of the Land Use Map and summary of the main elements of the Land Use Plan, a description of Coastal Act Consistency in terms of the resources protection program and development policies, and then the Plan's policies in terms of resource conservation and management, and then development.

The Implementing Actions Program (IAP) is the implementation program for The Newport Coast LCP and consists of Planned Community (PC) District Regulations, and related provisions, procedures, definitions, and descriptions, including the PC Zoning Map/Statistical Summary; the PC Development Map/Statistical Table, and referenced County of Orange Codes.

2. AREA DESCRIPTION

The Newport Coast Planning Unit contains 9,493 acres and is located along the southern coast of Orange County between Newport Beach and Laguna Beach. The Newport Coast generally extends from the Pacific Ocean to the ridge of the San Joaquin Hills. Geographically and topographically, the coastal area of The Irvine Ranch contains five distinct areas: the shoreline, the coastal shelf, gently sloping coastal hills, major canyons, and prominent ridgelines. (See Exhibit B.)

Three and one-half miles of meandering shoreline offer a variety of scenic views, recreational opportunities, and marine habitats. The coastline contains both sandy beaches and rocky shores.

Atop the coastal bluffs is a flat shelf extending inland to Pacific Coast Highway. Since most of the shelf between Pacific Coast Highway (PCH) and the ocean is now part of Crystal Cove State Park, this shelf offers significant coastal access and recreational opportunities.

Inland from Pacific Coast Highway, in the northwestern portion of the coastal area, sit the gently sloping hillsides and ridges of Pelican Hill and Wishbone Hill. These ridges and hillsides provide the majority of the developable land area outside the coastal shelf. These ridges and hillsides are divided and defined by three major canyon systems which extend perpendicular to the shoreline. Starting at the west, the canyons are Buck Gully, Los Trancos Canyon, and Muddy Canyon. Farther to the east are Moro and Emerald Canyons.

The southeastern portion of the coastal area, inland from Pacific Coast Highway, is dominated by three prominent ridges. No-Name Ridge is located between Muddy and Moro Canyons. Moro Ridge extends inland from Moro Hill and is bounded by Moro and Emerald Canyons. Finally, Emerald Ridge separates Emerald and Laguna Canyons.

3. RESOURCE DESCRIPTION

Vegetation (Flora). The Newport Coast includes a number of distinct habitats. Vegetative types include grassland, scrub, chaparral, riparian, and those plants associated with coastal beaches and cliffs. The coastal sage scrub plant community is well represented on the site. The most extensive vegetative growth in the area is the scrub, chaparral, and scrub-chaparral combination cover types.

Fish and Wildlife (Fauna). The diversified habitats of The Newport Coast support a faunal complement abundant in both species and individuals. During all or part of the year it can support a variety of species. These include many wildland species, as well as species associated with urban or agricultural habitats.



NATURAL TOPOGRAPHIC FEATURES- Second Amendment

The Newport Coast Local Coastal Program

Exhibit B

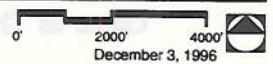

LEGEND

 PLANNED COMMUNITY BOUNDARY

Ecological Interrelationships. Human activities have had a major impact on the vegetation of the area. The Newport Coast is used predominantly for cattle grazing. The coastal bluffs were farmed for a number of years, but now support naturalized weedy plant species. Brush clearing and herbicide spraying of brushlands have been used to artificially expand the grasslands for improved cattle grazing and to prevent the invasion of brush into "pasture" areas.

Grazing itself has precipitated changes in vegetative species composition. Evidence of overgrazing (the presence of artichoke thistle and an abundance of cactus) is found in some locations in the area. As with other California grasslands, native perennial grasses have been replaced by introduced (naturalized) annual species.

A diversity of wildlife species is supported in the area. The number and diversity of species are enhanced by the presence of ecotones (edges between one habitat type and another) created by the variation in habitats, the small area covered by many of the habitat stands, and the mix of stands. The vegetation and wildlife are continuous with adjacent similar areas. The beach and cliff portion, however, is a separate entity; interaction between inland and coastal flora and fauna is minimal.

Wildlife utilizes natural features such as wooded canyons and ridgelines and man-made features such as roads and firebreaks. Water is available year-round for wildlife use in the form of seeps and springs in some canyon bottoms, and stock watering tanks on the ridges.

Marine Resources. The 3.5-mile shoreline of The Newport Coast is a series of coves with sandy beaches, interspersed with areas of rocky shore and headlands. Offshore, the sedimentary bottom is interrupted by jagged, rocky reefs extending from the intertidal zone to depths of 40 to 50 feet. Rocky outcroppings also occur at depths of 60 to 600 feet. The flora and fauna of these areas are highly diversified, particularly the rocky intertidal areas and the offshore kelp bed community.

In 1971, The Newport Coast shoreline was designated by the California Department of Fish and Game as The Irvine Coastal Marine Life Refuge. It is the largest marine life refuge in California - approximately 20,000 feet in length and 600 feet wide (i.e., 600 feet seaward of the "Line of Ordinary High Tide"). This area received its refuge status in order to protect and preserve the tide pools from excessive, consumptive public use. The area has been listed as a potential educational reserve

in the California Comprehensive Ocean Area Plan (California Department of Navigation and Ocean Development, 1972).

The Irvine Coastal Marine Life Refuge has been designated by the California State Water Resources Control Board as an Area of Special Biological Significance. The rationale for this designation includes the offshore kelp bed and the offshore reefs and pinnacles, which support a rich and diversified flora and fauna.

Paleontological Resources. The great bulk of The Newport Coast Planning Unit is underlain by marine sedimentary rocks of Miocene age. These include units of the Vaqueros Formation, the Topanga Formation, the San Onofre Formation, and the Monterey Formation. On a sensitivity scale of 1 to 10 (1 = lowest; 10 = highest), the Miocene rocks are rated from 6 to 8, and are considered to be of high-order paleontological significance.

Along the coast on both sides of Pacific Coast Highway, marine terrace deposits of late Pleistocene age are present. These deposits consist of silt, sand, and gravel and have yielded important fossils from a number of localities. These deposits are considered to be of high-order (9) paleontological significance.

Archaeological Resources. Nine separate archaeological surveys have been conducted within The Newport Planning Unit. Approximately 74 archaeological sites have been recorded.

Historical Resources. Historical resources are defined as items, deposits, structures, and foundations which have either local, State, or national historical significance and are generally older than 50 years. One Historical District has been identified at Crystal Cove within the State Park and for which the Park was named. Placed on the National Register of Historic Places as an Historical District in 1979, Crystal Cove consists of a small coastal resort community of some 44 cottages built during the 1920's and 1930's.

Visual Resources. The Newport Coast can be divided into two visual zones: coastal plain and coastal hills. The coastal plain, while relatively small compared to the entire project area, is the most important visual resource because of the proximity and compelling presence of the ocean.

The balance of the area is typical California coastal hills. The most common visual experience is the overlapping and multiple infoldings of canyons and ridges that describe the horizon.

The most significant visual resources which can be seen from Pacific Coast Highway are the ocean and landforms identified on Exhibit C. In all situations, the ocean is the dominant visual resource.

4. REGIONAL OPEN SPACE SETTING

From a regional perspective, the extensive open space areas of The Newport Coast described in the following Land Use Plan will work in concert with a series of other dedications and land uses to create a regional greenbelt comprising over 18,000 acres of land. In addition to the 7,343 acres of open space and recreation lands within The Newport Coast, the ultimate regional open space system will include the following elements:

- Laguna/Laurel Canyons Regional Park Area:¹ 1,300 acres comprising the Laurel Canyon and the Laguna Canyon ridge will be dedicated by The Irvine Company in conjunction with the development of The Laguna Canyon Village Planned Community.
- Laguna Canyon Golf Course:¹ An 18-hole golf course will be built immediately adjacent to the Laguna Canyon dedication area.
- Sycamore Hills Linkage:² A 370-acre area has been acquired by the City of Laguna Beach as part of the regional open space system.

¹ Approximately 1,400 acres of Laguna Canyon Ridge and adjacent areas, including three natural lakes, have been purchased by the City of Laguna Beach and are being managed by the County of Orange as part of the Laguna Coast Wilderness Regional Park.

² Sycamore Hills Park is owned by the City of Laguna Beach and is being managed by the County of Orange as part of the Laguna Coast Wilderness Regional Park.

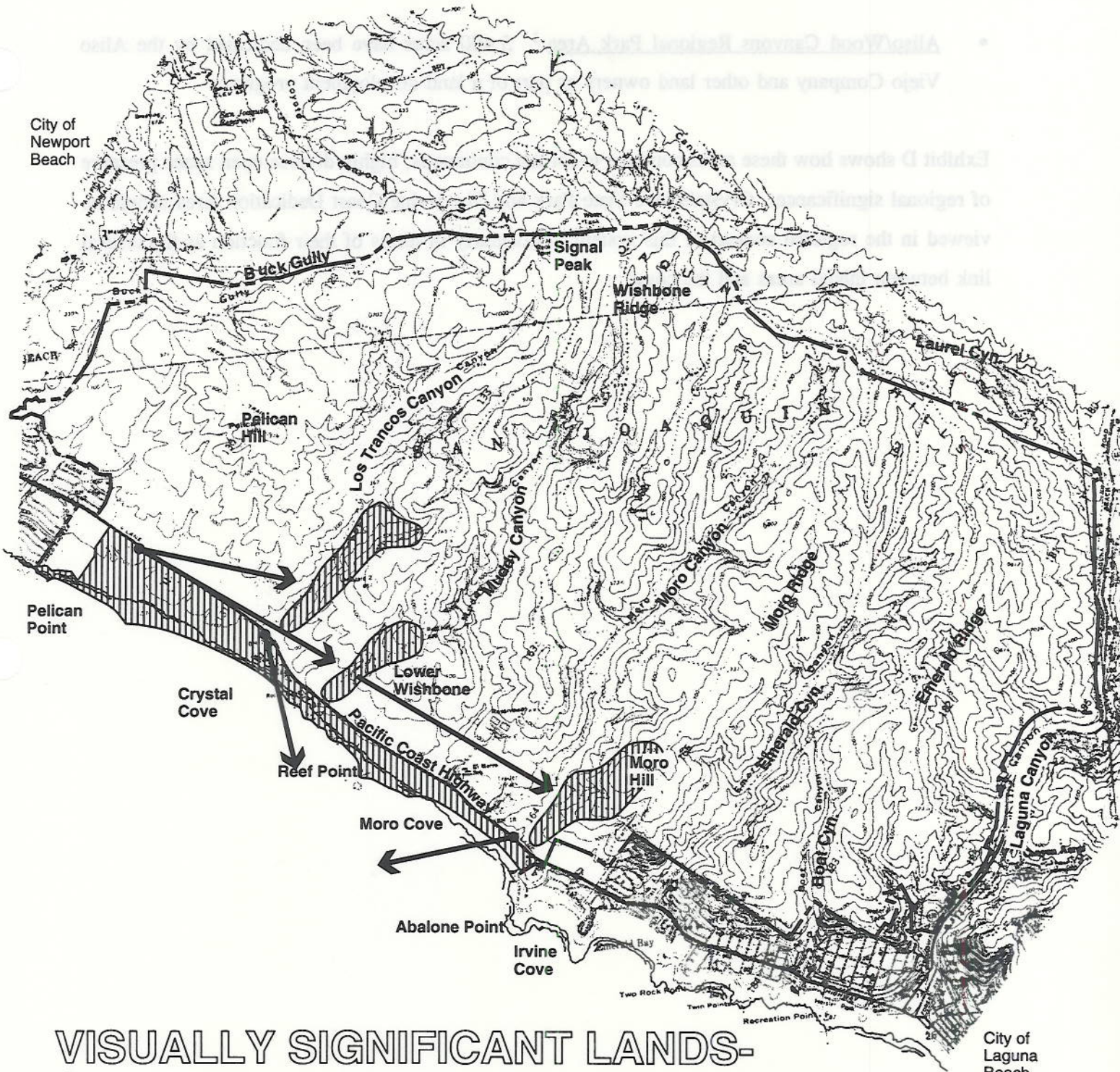



VISUALLY SIGNIFICANT LANDS- Second Amendment

The Newport Coast Local Coastal Program

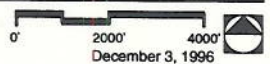
City of Laguna Beach
Exhibit C



LEGEND

-  PLANNED COMMUNITY BOUNDARY
-  VISUALLY SIGNIFICANT LANDS
-  VIEW FROM COAST HIGHWAY

- Aliso/Wood Canyons Regional Park Area:¹ 5,400 acres have been dedicated by the Aliso Viejo Company and other land owners as part of a land development program.

Exhibit D shows how these areas combine to form a continuous, highly diverse open space preserve of regional significance. Crystal Cove State Park and The Irvine Coast Dedication Area should be viewed in the regional context of this system, particularly in terms of their function as the critical link between inland areas and the coast.



¹ Aliso/Wood Canyons have been dedicated by the Mission Viejo Company and other landowners as part of the Aliso Viejo development program and are included as part of the County's Laguna Coast Wilderness Regional Park.

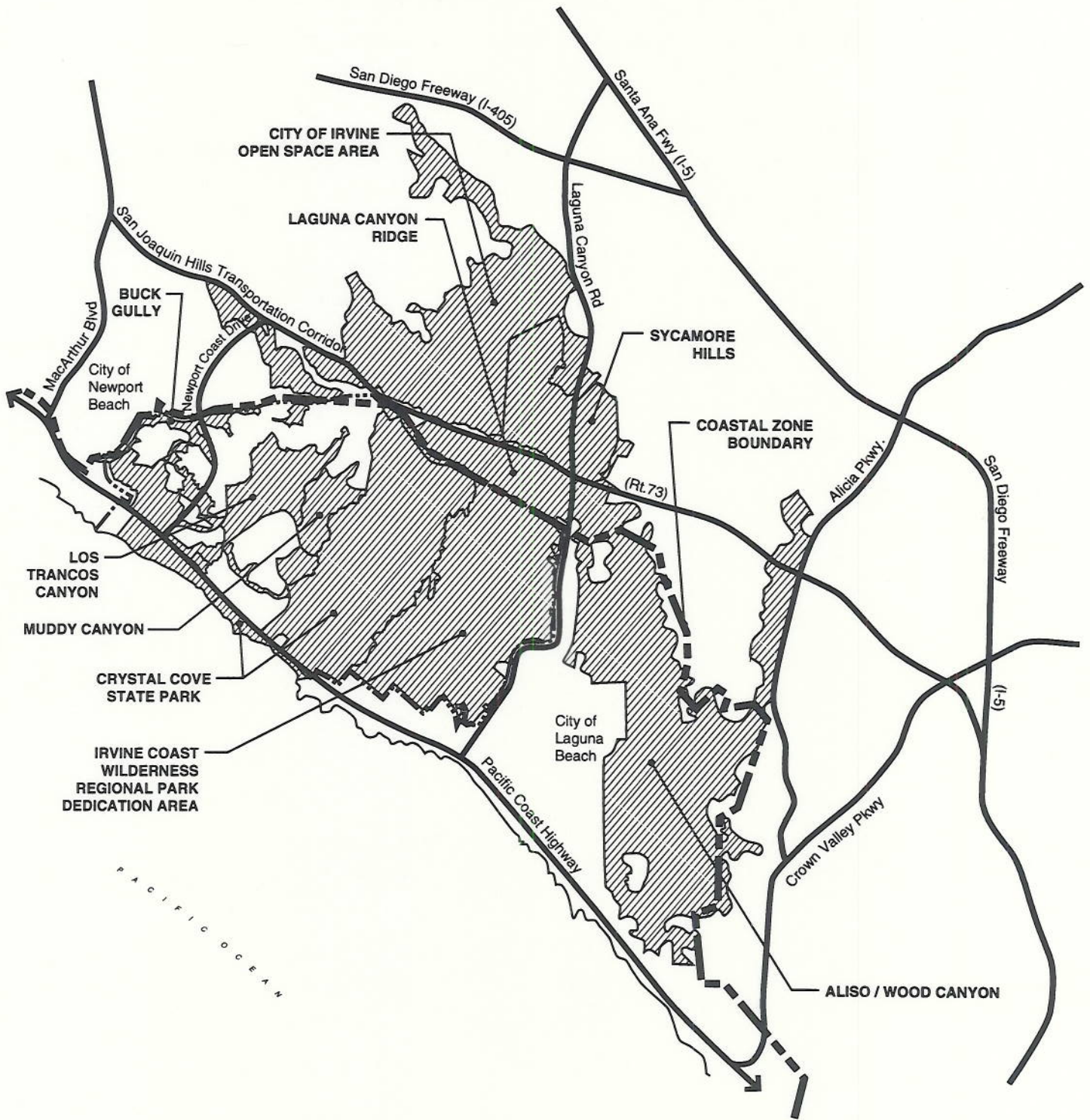

REGIONAL OPEN SPACE CONCEPT- Second Amendment

The Newport Coast Local Coastal Program

Exhibit D

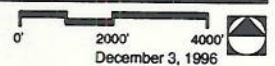



REGIONAL OPEN SPACE CONCEPT-
Second Amendment

The Newport Coast Local Coastal Program

Exhibit D



I-1. Main Elements of the
Land Use Plan

LAND USE PLAN

CHAPTER 1

MAIN ELEMENTS OF THE LAND USE PLAN

The Land Use Plan for The Newport Coast LCP consists of maps, policies, and supporting text organized under three subsequent chapter headings: Coastal Act Consistency and Overall Findings and Conclusions, Resource Conservation and Management Policies, and Development Policies.

Zoning and subsequent actions by the County must be consistent with the policies contained in the adopted County of Orange General Plan. The Newport Coast Land Use Plan is consistent with the General Plan, and contains some land use descriptions and policies which are more specific and apply exclusively to The Newport Coast.

The Land Use Plan for The Newport Coast recognizes the special qualities of the land, and the need for protection of the environment and sensitive utilization of coastal resources. It proposes land uses, open space, and resource protection which, on balance, are the most protective of the environment, the public interest, and private property rights. As such, it meets the intent of Section 30007.5 of the California Coastal Act of 1976.

A. OPEN SPACE

The centerpiece of the Land Use Plan is open space lands which comprise over 77% of the entire Newport Coast. The Newport Coast will have approximately 4,989 acres of land in recreation use, including Crystal Cove State Park, Buck Gully, Los Trancos and Muddy Canyons, and several smaller parcels. The California Coastal Commission has already approved a separate Public Works Plan for Crystal Cove State Park which is consistent with this Land Use Plan. In addition, 2,000 acres of Conservation land, including the lower portions of Boat and Emerald Canyons, will be dedicated to the County of Orange in a phased program as part of the County's Irvine Coast Wilderness Regional Park, linked to the development of Residential, Golf Course, and Tourist Commercial uses.

EXHIBIT E
SECOND AMENDMENT
LAND USE SUMMARY
Newport Coast Local Coastal Program

<u>LAND USE CATEGORY</u>	<u>PLANNING AREAS</u>	<u>GROSS ACRES¹</u>
RESIDENTIAL:		
Low Density	6, 7A, 7B	130
Medium-Low Density	5, 9	201
Medium Density	1B, 2A, 2B, 2C, 3A, 3B, 4A, 4B	1,296
High Density	1A, 1C, 8	246
SUBTOTAL		1,873 ACRES
COMMERCIAL:		
Tourist Commercial	13A, 13B, 13C, 13D, 13E, 13F, 14, 20A	277
SUBTOTAL		277 ACRES
OPEN SPACE:		
Golf Course	10A, 10B	354 ²
Recreation and Parks	11A, 11B, 12A, 12B, 12C, 12D, 12E, 12F, 12G, 12H, 12I, 12J, 17, 18, 19, 20B, 20C	4,989
Conservation	21A, 21B, 21C, 21D, 16A, 16B	2,000
SUBTOTAL		7,343 ACRES
<u>TOTAL — ALL LAND USES</u>		<u>9,493 ACRES</u>

¹ All acreages are approximate and include roads and arterial highways.

² In addition to the 354 acres in Golf Course Planning Areas PA 10A and PA 10B, the two 18-hole golf courses and practice facility encompass an additional 74 acres within Tourist Commercial Planning Areas and 27 acres in Residential Planning Area PA 9 for a total of 455 acres devoted to golf course use.

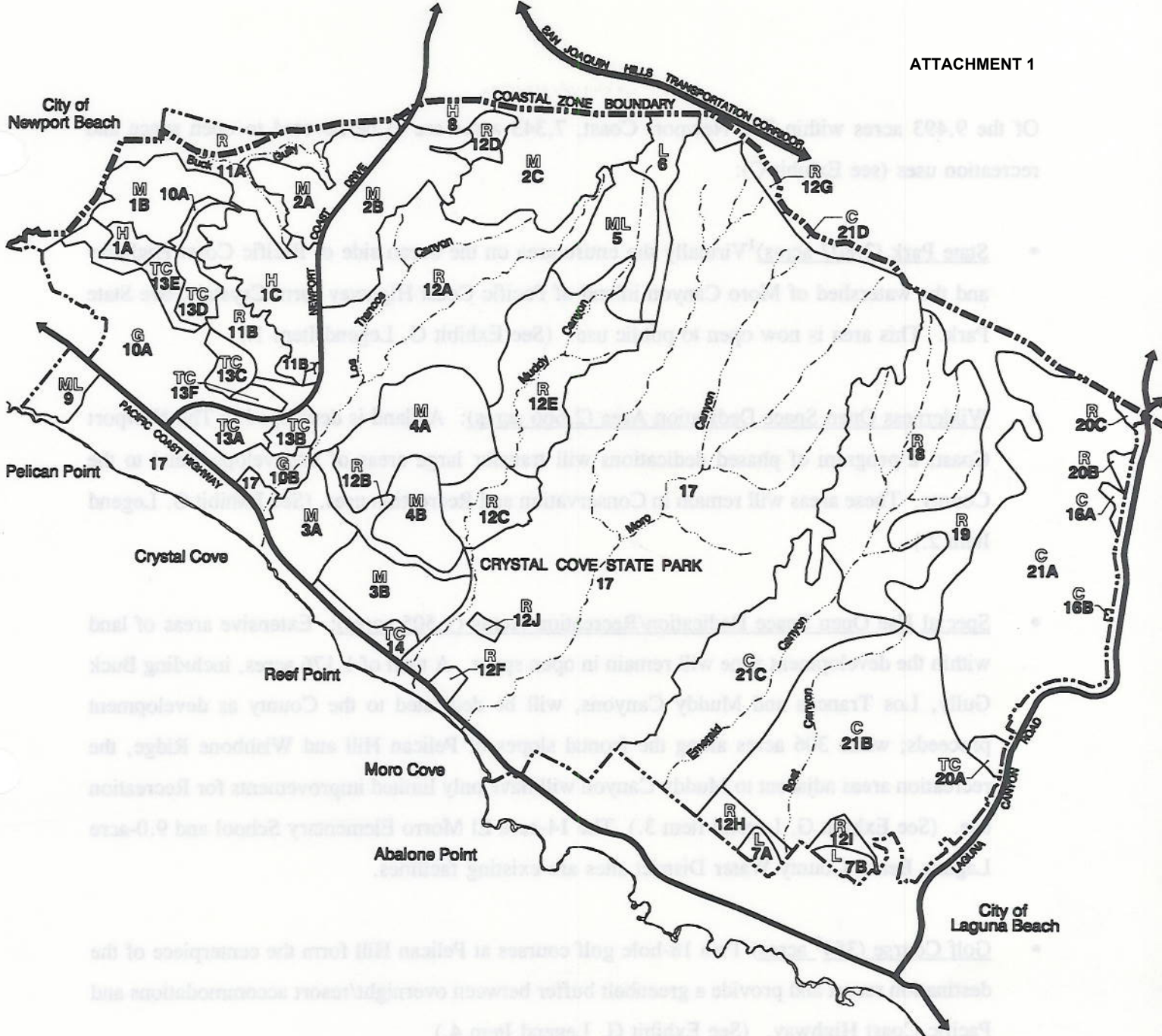

LAND USE PLAN - Second Amendment

The Newport Coast Local Coastal Program

Exhibit F

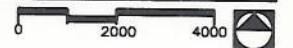

December 3, 1998

LEGEND

LOW DENSITY RESIDENTIAL (0-2)	LAND USE DESIGNATION
MEDIUM-LOW DENSITY RESIDENTIAL (2-3.5)	PLANNING AREA NUMBER
MEDIUM DENSITY RESIDENTIAL (3.5-6.5)	COASTAL ZONE BOUNDARY
HIGH DENSITY RESIDENTIAL (6.5-18)	PLANNED COMMUNITY BOUNDARY
GOLF COURSE	PLANNING AREA BOUNDARY
TOURIST COMMERCIAL	
RECREATION	
CONSERVATION	

Of the 9,493 acres within The Newport Coast, 7,343 acres are to be devoted to open space and recreation uses (see Exhibit G):

- State Park (2,807 acres)¹ Virtually the entire area on the ocean side of Pacific Coast Highway and the watershed of Moro Canyon inland of Pacific Coast Highway form Crystal Cove State Park. This area is now open to public use. (See Exhibit G, Legend Item 1.)
- Wilderness Open Space Dedication Area (2,666 acres): As land is developed in The Newport Coast, a program of phased dedications will transfer large areas of undeveloped land to the County. These areas will remain in Conservation and Recreation uses. (See Exhibit G, Legend Item 2.)
- Special Use Open Space Dedication/Recreation Areas (1,505 acres): Extensive areas of land within the development zone will remain in open space. A total of 1,176 acres, including Buck Gully, Los Trancos and Muddy Canyons, will be dedicated to the County as development proceeds; while 306 acres along the frontal slopes of Pelican Hill and Wishbone Ridge, the recreation areas adjacent to Muddy Canyon will have only limited improvements for Recreation use. (See Exhibit G, Legend Item 3.) The 14-acre El Morro Elementary School and 9.0-acre Laguna Beach County Water District sites are existing facilities.
- Golf Course (354² acres) Two 18-hole golf courses at Pelican Hill form the centerpiece of the destination resort and provide a greenbelt buffer between overnight/resort accommodations and Pacific Coast Highway. (See Exhibit G, Legend Item 4.)

¹ Sale and dedications of Crystal Cove State Park completed.

² In addition to the 354 acres in Golf Course Planning Areas 10A and 10B, the two 18-hole golf courses and practice facility encompass an additional 74 acres within Tourist Commercial Planning Areas and 27 acres in Residential Planning Area 9, for a total of 455 acres devoted to golf course use.

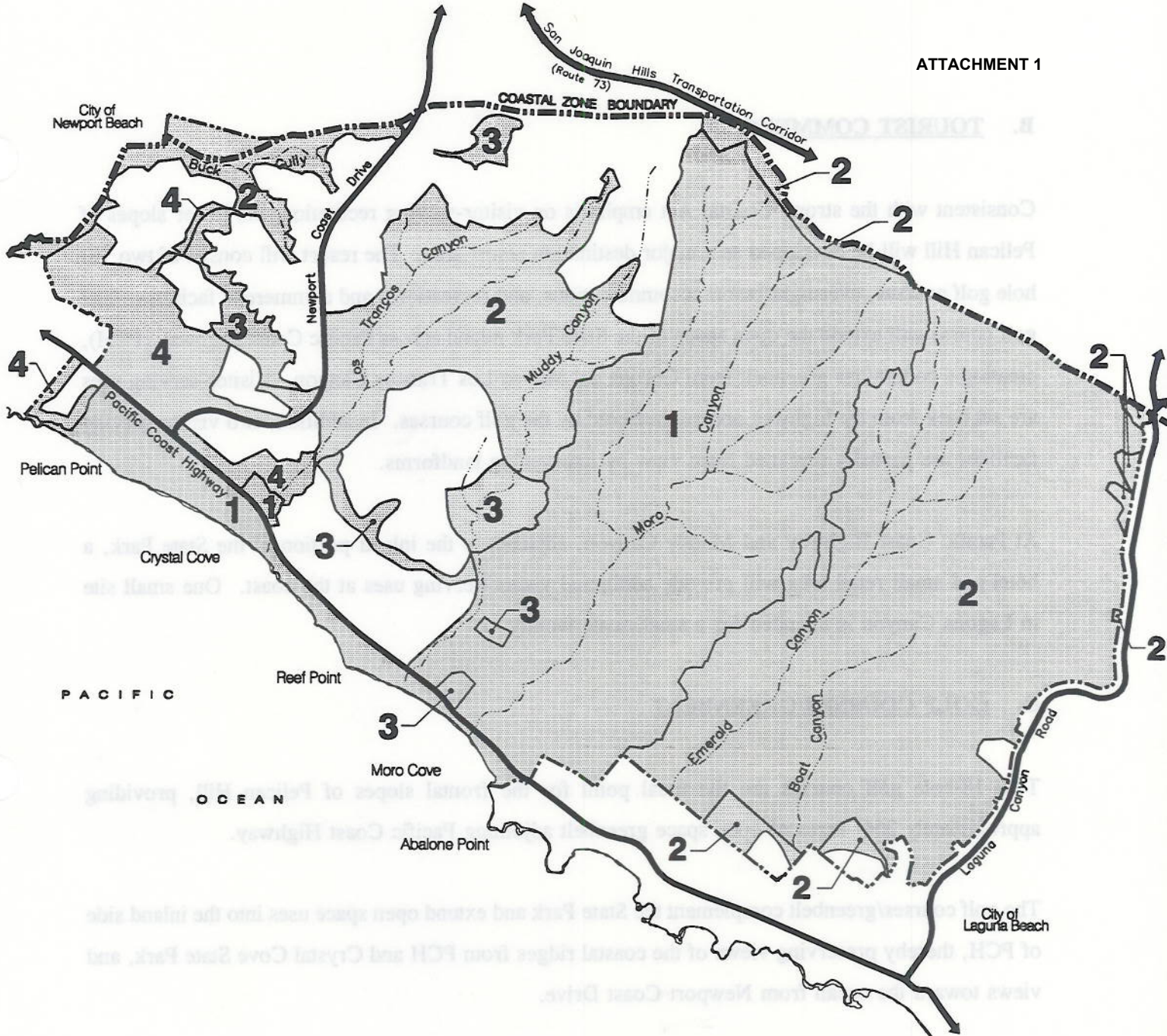

NEWPORT COAST OPEN SPACE - Second Amendment

The Newport Coast Local Coastal Program

Exhibit G

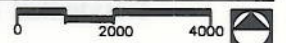

December 3, 1996

LEGEND

- 1 CRYSTAL COVE STATE PARK
- 2 DEDICATION AREAS
- 3 OTHER OPEN SPACE
- 4 GOLF COURSE
- COASTAL ZONE BOUNDARY
- PLANNED COMMUNITY BOUNDARY
- DRAINAGE COURSE

B. TOURIST COMMERCIAL

Consistent with the strong Coastal Act emphasis on visitor-serving recreation, the lower slopes of Pelican Hill will be developed as a major destination resort area. The resort will consist of two 18-hole golf courses, overnight/resort accommodations, and recreational and commercial facilities. The golf course will extend the open space of the State Park inland across Pacific Coast Highway (PCH), creating a continuous greenbelt from Corona del Mar to Los Trancos Canyon. Visitor-serving uses are set back from the highway and are buffered by the golf courses. In addition, two visitor-serving facilities are partially screened from view by intervening landforms.

At Pacific Coast Highway and Muddy Canyon, adjacent to the inland portion of the State Park, a hotel and small retail area will provide additional visitor-serving uses at the coast. One small site in Laguna Canyon is intended for a small-scale facility.

C. GOLF COURSES/GREENBELT

Two 18-hole golf courses are the focal point for the frontal slopes of Pelican Hill, providing approximately 354¹ acres of open space greenbelt adjoining Pacific Coast Highway.

The golf courses/greenbelt complement the State Park and extend open space uses into the inland side of PCH, thereby preserving views of the coastal ridges from PCH and Crystal Cove State Park, and views toward the ocean from Newport Coast Drive.

D. RESIDENTIAL

Residential development will be limited to a maximum of 2,600 dwelling units. Compliance with the County's Housing Element will be demonstrated in a Housing Implementation Plan. Clustering of residential units will preserve open space, reduce grading impacts, and enhance the compatibility of private development with public open space.

¹ In addition to the 354 acres in Golf Course Planning Areas PA 10A and PA 10B, the two 18-hole golf courses and practice facility encompass an additional 74 acres within Tourist Commercial Planning Areas and 27 acres in Residential Planning Area PA 9, for a total of 455 acres devoted to golf course use.

E. CIRCULATION

There is a hierarchy of roadways which will serve The Newport Coast. These include the regional freeway and highway network, subregional arterial highway network, and local collectors.

Newport Coast Drive is designated as a major arterial (six lanes) on the County of Orange Master Plan of Arterial Highways, as is Pacific Coast Highway through portions of The Newport Coast Area. Laguna Canyon Road, which exists along the easterly boundary of The Newport Coast Area, is master planned as a primary arterial (four lanes).

Outside the coastal zone, the regional network providing access to The Newport Coast includes segments of both the Federal Interstate Freeway System as well as the State Highway System. Presently, the only direct access is provided by Pacific Coast Highway¹ (SR 1). PCH is currently subject to heavy levels of traffic during commuting hours, which is primarily a result of traffic diverting to avoid the congested I-5 and I-405 Freeways. South of The Newport Coast, in the City of Laguna Beach, Pacific Coast Highway connects to inland areas via Laguna Canyon Road/ Laguna Freeway (SR 133). North of The Newport Coast, in the City of Newport Beach, Pacific Coast Highway connects to inland areas via MacArthur Boulevard (SR 73), Jamboree Road, and Newport Boulevard/Costa Mesa Freeway (SR 55). These routes, in turn, provide connection to the San Diego Freeway (I-405) and the Santa Ana Freeway (I-5). Major additions to the regional network includes the extension of the Costa Mesa Freeway and the San Joaquin Hills Transportation Corridor which will provide direct access to the inland edge of The Newport Coast planning areas.

F. PUBLIC WORKS/INFRASTRUCTURE

The Newport Coast Planning Unit is entirely within the Irvine Ranch Water District (IRWD) except for a limited portion of the dedication area and two small residential areas which are within the Laguna Beach County Water District. The area generally west of Muddy Canyon is within IRWD Improvement District Number 141, while the area generally east of Muddy Canyon is within IRWD Improvement District Number 142.

¹ Coastal access is provided by Newport Coast Drive, San Joaquin Hills Road and Pacific Coast Highway. All LCP designated road improvements, including the widening of Pacific Coast Highway have been completed.

Sewer service will be provided by a combination of agencies. The area west of Muddy Canyon is within Orange County Sanitation District (OCSD) Number 5. At the time that this area was annexed to OCSD Number 5, IRWD agreed to provide local sewer service and collection, and OCSD Number 5 agreed to provide regional sewage collection, transmission, and treatment. The area east of Muddy Canyon will be served by IRWD through the Aliso Water Management Agency.

Newport Coast Drive is designated as a major arterial (see map) on the County of Orange Master Plan of Arterial Highway, as is Pacific Coast Highway through portions of The Newport Coast Area. Laguna Canyon Road, which exists along the easterly boundary of The Newport Coast Area, is master planned as a primary arterial (see map).

Outside the coastal zone, the regional network providing access to The Newport Coast includes segments of both the Federal Interstate Freeway System as well as the State Highway System. Presently, the only direct access is provided by Pacific Coast Highway (SR 1). PCH is currently subject to heavy levels of traffic during commuting hours, which is generally a result of traffic diverting to avoid the congested I-5 and I-405 Freeways. South of The Newport Coast, in the City of Laguna Beach, Pacific Coast Highway connects to inland areas via Laguna Canyon Road. Laguna Freeway (SR 133), North of The Newport Coast, in the City of Newport Beach, Pacific Coast Highway connects to inland areas via MacArthur Boulevard (SR 73), Jamul Road, and Newport Boulevard/Costa Mesa Freeway (SR 55). These routes, in turn, provide connections to the San Diego Freeway (I-405) and the Santa Ana Freeway (I-5). Major additions to the regional network include the extension of the Costa Mesa Freeway and the San Joaquin Hills Transportation Corridor which will provide direct access to the inland edge of The Newport Coast planning area.

F. PUBLIC WORKS/INFRASTRUCTURE

The Newport Coast Planning Unit is entirely within the Irvine Ranch Water District (IRWD) except for a limited portion of the dedication area and two small residential areas which are within the Laguna Beach County Water District. The area generally west of Muddy Canyon is within IRWD Improvement District Number 141, while the area generally east of Muddy Canyon is within IRWD Improvement District Number 142.

1. Current access is provided by Newport Coast Drive, San Joaquin Hills Road and Pacific Coast Highway. All I-5 designated east improvement, including the widening of Pacific Coast Highway have been completed.

**I-2. Coastal Act Consistency/
Overall Findings and Conclusions**

CHAPTER 2

COASTAL ACT CONSISTENCY

AND OVERALL FINDINGS AND CONCLUSIONS

Among the primary goals of the Coastal Act are the protection of coastal resources and provision of public access to the coast. The Legislature also recognized that conflicts might occur when carrying out all of the Act's policies. The Legislature, therefore, established a "balancing" test. This test allows the Coastal Commission to approve a plan which, although it may cause some damage to an individual resource, on balance is more protective of the environment as a whole (Public Resources Code Section 30007.5). Public acquisition of large, continuous open space areas is recognized as a superior means to guarantee the preservation of coastal resources such as vegetation, wildlife, and natural landforms, and to create new public access and recreation opportunities rather than preserving small pockets of open space surrounded by development.

The Newport Coast Plan strikes a balance in two ways which are consistent with the intent of the Act. First, a substantial portion of the area is designated for preservation in its natural state. Second, policies have been developed to address a wide range of issues in areas of The Newport Coast designated for development and to mitigate potential adverse impacts. (See also "California Coastal Commission Findings for LUP Certification", November 4, 1981, in Appendix 1.)

A. RESOURCES PROTECTION PROGRAM

1. OPEN SPACE DEDICATION PROGRAMS

The purpose of the Open Space Dedication Programs is to protect certain specified coastal resources and to offset adverse environmental impacts in residential development areas which will not otherwise be mitigated. Permanent protection and preservation of major canyon watersheds, visually significant ridgelines, stream courses, archaeological and paleontological sites, riparian vegetation, coastal chaparral and wildlife habitat is provided by dedication to a public agency (the County of Orange or its designee). Environmental impacts to be mitigated by the dedication programs include habitat and archaeological impacts caused by residential development and road improvements on Pelican Hill, habitat impacts on Los Trancos Canyon,

Buck Gully, and Muddy Canyon caused by the construction of Newport Coast Drive, public view and use impacts caused by residential construction in the Pelican Point area and adjacent to Crystal Cove State Park, and scenic resource impacts caused by golf course and tourist commercial development on the frontal slopes of Pelican Hill and Lower Wishbone.

Large-scale master planning and dedication programming for The Newport Coast enables the permanent protection of large, contiguous open space areas rather than the protection of smaller, discontinuous habitat areas that might result from a project-by-project site mitigation approach. A much greater degree of habitat and open space protection can be achieved by dedication programs that assemble large blocks of habitat area contiguous to Crystal Cove State Park than would be possible with project-by-project mitigation measures. (Coastal Commission Appeal No. 326-80, Broadmoor, Page 18.)

While specific mitigation measures are being included for potential impacts within or near the development areas (e.g., erosion control measures), the primary mitigation measure for impacts not avoided is the phased "Wilderness" Open Space Dedication Program. In addition, significant additional habitat protection and development mitigation will be accomplished with the dedication of large areas of Los Trancos Canyon, Buck Gully, and Muddy Canyon through the "Special Use" Open Space Dedication Program.

Consistent with Coastal Act Section 30200, most of the more significant Environmentally Sensitive Habitat Areas (ESHA's) are located within, and will be protected by, conservation and recreation land use categories. The Land Use Plan recognizes that the preservation of these particular resources and the Open Space Dedication Programs are more protective of coastal resources than the protection of more isolated and relatively less significant habitat areas within designated residential and commercial development areas. Hence the potential loss of any ESHA's through development is offset by the Open Space Dedication Programs. The potential loss of any ESHA's through the construction of public facilities such as arterial highways is offset by the coastal access benefits derived from these roadways as well as the Open Space Dedication Programs.

In accordance with Section 30007.5 of the Coastal Act, the major Open Space Dedication Programs creates the balance which allows the completion of the residential and commercial land uses.

2. ENVIRONMENTALLY SENSITIVE HABITAT AREAS

For purposes of Section 30107.5 of the Coastal Act, natural drainage courses designated by a dash and three dot symbol on the USGS 7.5-minute series map, Laguna Beach Quadrangle, dated 1965 and photo-revised 1972 (hereafter referred to as "USGS Drainage Courses"), riparian vegetation associated with the aforementioned drainage courses, coastal waters, wetlands, and estuaries are classified as "Environmentally Sensitive Habitat Areas" (ESHA's).

The habitat value along the length of individual drainage courses and among different drainage courses is not equal. The habitat value of the coastal waters is different from that for drainage courses. Based on biological studies, (see biological inventory, Appendix H-1, Final EIR 237 and Pelican Hill Drainage Habitat, LCP Appendix Item 2) four categories of ESHA's have been created to differentiate habitat values as shown on Exhibit H.

a. ESHA Category A:

USGS Drainage Courses with associated riparian vegetation which contain the most significant habitat areas in The Newport Coast are designated as ESHA Category A, are subject to the most protection, and are located entirely within the Recreation and Conservation land use categories. To assure their long-term protection and as a means of providing a unique park setting for future residents of The Newport Coast and of the region, portions of Buck Gully and Los Trancos and Muddy Canyons, will be dedicated to the County of Orange in accordance with policies of this LUP. Public access to these areas will be via linkages with the Newport Coast Drive Trail System, Los Trancos parking lot, and the Crystal Cove State Park Trail System.

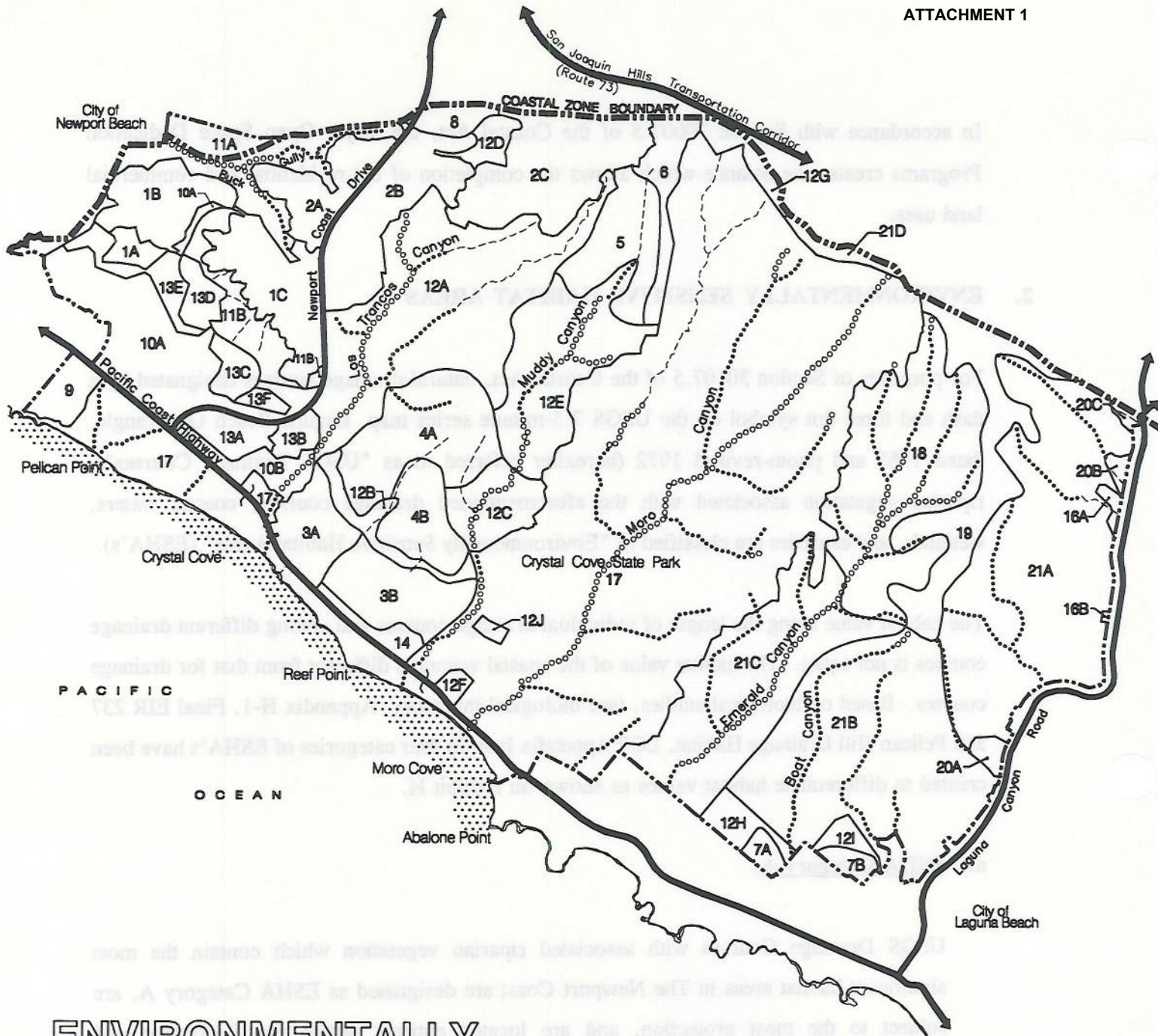

ENVIRONMENTALLY SENSITIVE HABITAT AREAS - Second Amendment

The Newport Coast Local Coastal Program

Exhibit H

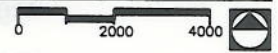

December 3, 1996

LEGEND

- CATEGORY A - DRAINAGE COURSE/RIPARIAN VEGETATION
- CATEGORY B - DRAINAGE COURSE
- CATEGORY C - COASTAL WATERS
- CATEGORY D - DRAINAGE COURSE
- COASTAL ZONE BOUNDARY
- PLANNED COMMUNITY BOUNDARY
- PLANNING AREA BOUNDARY
- PLANNING AREA

Note: Category D ESHAs have been deleted in areas with previously approved Coastal Development Permits as permitted by land use policies and mitigated by the Riparian Habitat Creation Program.

Nine surface water sources have been identified (refer to EIR 237, Figure 25) in Buck Gully, Los Trancos, Moro, and Emerald Canyons. All nine water sources come from natural seeps, although two of the three sources in Buck Gully are probably augmented by percolating irrigation runoff from adjacent development. Flow from all nine seeps occurs all or most of the year during average rainfall years, although downstream flow may be very limited. These USGS Drainage Courses are the most significant ESHA's in The Newport Coast because they contain all of the following habitat characteristics: 1) standing or flowing water all or a significant part of the year; 2) a definitive stream bottom (i.e., defined banks with a sandy or rocky bottom); and 3) adjacent riparian vegetation lining the water course.

b. ESHA Category B:

USGS Drainage Courses which contain water flows only when it rains and support only small amounts of riparian vegetation, are designated as ESHA Category B. These areas have relatively less habitat value and except for the ESHA Category B located within Planning Area 4A are located in Recreation and Conservation land use categories.

c. ESHA Category C:

The coastal waters along The Newport Coast -- ESHA Category C -- have been designated as both a Marine Life Refuge and an Area of Special Biological Significance. They contain near shore reefs, rocky intertidal areas and kelp beds, and are located primarily within Crystal Cove State Park. The State Department of Parks and Recreation will be responsible for providing protection for tidepools and other marine resources from park users.

Protection of water quality is provided by the Runoff Policies.

d. **ESHA Category D:**

ESHA Category D designates USGS Drainage Courses which are deeply eroded and of little or no riparian habitat value. They are located in Residential and Commercial land use categories and two specific Recreation sites. Typical vegetation includes elderberry, arroyo, coastal scrub, and annual grassland. These drainage courses are often incised as a result of erosion, resulting in rapid runoff and very steep narrow sideslopes generally incapable of supporting riparian habitat. Development will impact most of these ESHA's. The Open Space Dedication and Riparian Habitat Creation Programs will mitigate development impacts.

3. RIPARIAN HABITAT CREATION PROGRAM

Golf course and visitor-serving development in PA 10A, PA 10B, PA 13A, PA 13B, PA 13C, PA 13D, PA 13E, and PA 13F will modify drainage courses that are presently degraded. Any habitat impacts resulting from drainage course modifications will be mitigated by the Riparian Habitat Creation Program and the Open Space Dedication Programs.

4. EROSION CONTROL AND URBAN RUNOFF

The primary measure for minimizing potential erosion and urban runoff impacts is the permanent preservation in open space of over 77% of The Newport Coast. Additionally, specific development standards assure that, to the extent feasible, unavoidable impacts within the development areas are mitigated.

The major objective of the Erosion and Urban Runoff Management Policies for The Newport Coast is to assure that erosion and runoff rates do not significantly exceed natural rates, while at the same time assuring sand replenishment provided within the coastal watershed is maintained (The Newport Coast littoral "cell" is limited and partially dependent on the local watershed for sand replenishment.)

Marine water quality will be protected by directing runoff to natural drainage courses such as Los Trancos Canyon, Buck Gully, and Muddy Canyon, through the use of landscaped drainages in the golf course (including the new riparian habitat area), and by means of erosion control techniques to slow runoff so that habitat areas are protected from flows significantly in excess of natural rates of flow. Additional control of non-point sources will be implemented if necessary to comply with State, regional and County standards. These measures may include street-sweeping, catch basin cleaning, efficient landscaping practices, and control of chemical applications.

5. VISUAL QUALITY

The Coastal Act requires that new development be sited and designed in such a way as to protect views to and along the ocean and scenic coastal areas (Section 30251). The visually significant lands and primary public views in The Newport Coast are depicted on Exhibit C and Appendix Item 6. The policies and land uses of The Newport Coast LUP reviewed below, in association with the State Park purchase and private donations, address "visual quality" in a comprehensive manner and protect views of each of the major landforms depicted on Exhibit C. Additionally, the creation of the golf course greenbelt enhances the visual qualities of the frontal slopes of Pelican Hill by providing year-round greenery and by providing a scenic foreground for the visitor-serving areas.

a. Views from PCH toward the Ocean:

The original 1976 Irvine Coast LUP had proposed visitor-serving uses on the coastal shelf between PCH and the ocean. In order to accommodate the objectives of the California Department of Parks and Recreation (State Parks) and in response to community concerns, the proposed overnight/resort accommodations were relocated inland to the Pelican Hill area (PA 13A and PA 13B). As a consequence, Crystal Cove State Park now comprises the most extensive area of open coastal shelf, visible from PCH, between Newport Beach and Camp Pendleton.

Additionally, The Irvine Company is funding and implementing a landscape program under State Parks' direction that will attempt to screen views of the State Park parking lots from PCH while still preserving views of the ocean and enhancing the major entries into Crystal Cove State Park at Pelican Point and Reef Point. This landscaping program has been implemented in conjunction with the coastal permit for The Irvine Company's Irvine Cove Crest development.

b. Views from the Moro Ridge Area of Crystal Cove State Park:

Following the State Parks' acquisition of the coastal shelf and Moro Canyon, The Irvine Company donated Moro Ridge to State Parks. This gift to the State of California preserved the dominant backdrop for inland views from PCH and the coastal shelf, and also provided a major public recreation use area.

In addition to the scenic benefits of protecting the ridge itself, dramatic downcoast views from the ridge toward Laguna Beach will be protected by the Open Space Dedication Programs. As a result, the downcoast viewshed visible from Moro Ridge will be preserved and direct views of the ocean from the ridge will be unobstructed.

c. Views Inland from PCH and the Coastal Shelf:

The golf courses on the frontal slopes of Pelican Hill will play a central role in scenic protection, creating a greenbelt which complements the open space area of the coastal shelf on the ocean side of PCH. They will preserve the character of the lower knolls on the frontal slopes, the most visible landform and dominant feature of the hillside from PCH and the coastal shelf. They will provide a greenbelt setting for the visitor-serving use while at the same time serving as a setback for tourist commercial areas from PCH. Finally, the golf courses will open views of the inland ridge between Cameo Highlands and Newport Coast Drive, and enhance the sense of arrival at the coast when emerging onto the coastal shelf from Corona del Mar.

d. Views from Newport Coast Drive:

Views from Newport Coast Drive vary dramatically as the roadway begins to descend from the ridge toward the coast. The Plan has been designed to emphasize selected views of Los Trancos Canyon; views of the ocean upcoast toward Newport Beach and framed by the golf courses; and the sense of arrival at the destination resort and at the coast immediately across Pacific Coast Highway.

B. DEVELOPMENT POLICIES

1. TOURIST COMMERCIAL

a. Visitor-Serving Functions:

Section 30222 of the Coastal Act requires that "the use of private lands suitable for visitor-serving commercial recreational facilities designed to enhance public opportunities for coastal recreation shall have priority over private residential, general residential or general commercial development...." Section 30223 of the Coastal Act provides that "upland areas necessary to support coastal recreational uses shall be reserved for such uses, where feasible."

The Newport Coast Land Use Plan carries out these policies by providing major day-use and overnight/resort facilities in close proximity to Crystal Cove State Park and, in particular, at locations in close proximity to the major beach areas. The Plan also provides tourist commercial areas which not only will fill a long-term need but will provide facilities that cannot be provided by the State Park. Due to existing mobile homes and cottage leases in the Moro and Crystal Cove areas, recreational facilities required to support park use will be severely limited until the leases are terminated. The proposed Newport Coast visitor-serving facilities will fill this gap in services.

By providing substantial day-use services (e.g., restaurants, food facilities, etc.) within walking distance of the beach, the need for construction of extensive support services on

State Park land seaward of Pacific Coast Highway will be substantially reduced. This not only carries out Section 30223 of the Coastal Act but also furthers the goals of Section 30221 by diminishing the need for construction of facilities in the viewshed from the highway toward the ocean. In this way, more of the coastal bluff park area can be used for actual recreational use pursuant to Section 30221 of the Coastal Act.

b. Location of Visitor-Serving Uses:

The Coastal Act provides for locating visitor-serving facilities at "selected points of attraction for visitors" (Section 30250(c)). In addition to day-use needs, projections of commercial recreation needs indicate a significant demand for new overnight/resort facilities (e.g., the figures cited in the Dana Point Specific Plan) which will be fulfilled by the provision of overnight/resort accommodations. On the entire Orange County coastline, only one other undeveloped area remains with the significant potential for accommodating visitor-serving uses (i.e., Dana Point Headlands). Thus, The Newport Coast is one of the few remaining areas where commercial recreation can be provided, and is the only site with convenient pedestrian access to a State Park.

c. A Destination Resort:

In furtherance of Coastal Act Sections 30222, 30223, and 30250(c), The Newport Coast LUP is structured to create the setting for a "destination resort". Unlike an individual hotel or a lodge oriented to attract a particular type of clientele, a destination resort is designed to provide a broad range of accommodations and recreational facilities which combine to create a relatively self-contained, self-sufficient center for visitor activities. By providing on-site recreational facilities, the destination resort will attract longer term visitors, as well as those staying only a few days. As a consequence, accommodations may range from hotel rooms to "casitas" and other types of lodging containing kitchen facilities and room combinations to serve guests staying for a variety of time periods. (Casitas are overnight/resort lodgings consisting of multiple bedrooms that may be rented separately and which may connect with a central living area that may include cooking facilities.) Traditional hotels with guest rooms may combine with individual studio, one bedroom and

multiple bedroom units to offer a spectrum of accommodations to suit varying lengths of stay, family sizes, and personal preferences.

Recreational amenities within the resort will include golf course(s), beach access, swimming pool(s), tennis courts, health spa(s), and other facilities. Commercial retail uses and a variety of restaurants will serve the needs of guests and day-use visitors and help create a setting and sense of place for an active resort community. Meeting rooms and conference space and facilities will be included to serve group activities.

The destination resort planned for Pelican Hill has the potential for serving a much broader range of visitors than hotel developments recently completed in southern Orange County and in other coastal areas such as Long Beach. By providing facilities capable of serving families and other types of users who may wish to stay for several days or more, the destination resort will function in a manner comparable to major resorts in Hawaii, Colorado ski areas, Lake Tahoe, Silverado in the Napa Valley, and Sun River in Oregon. The inclusion of overnight/resort accommodations which can provide multiple bedrooms and also contain kitchen facilities allows for family use in ways that are not generally accommodated in traditional hotels. Because food costs are a significant aspect of family travel costs, the ability to prepare meals within the accommodation and to provide facilities for children creates a type of overnight/resort facility used in other settings on the California Coast such as Monterey Dunes Colony in Monterey County, Pajaro Dunes in Santa Cruz County, and Sea Ranch in Sonoma County. Likewise, these types of accommodations can be more attractive to other long-term visitors than are traditional hotel rooms. Presently there is no true destination resort on the Orange County coast which complements the visitor attractions provided by local beaches and the communities of Laguna Beach and Newport Beach in a manner comparable to Pebble Beach in Monterey.

The Pelican Hill destination resort will provide a golf course "greenbelt", vistas of the ocean, access to the beach, and a wide variety of accommodations, all of which combine to carry out the strong Coastal Act policies of supporting visitor use of the coast.

d. **Enhancement of Inland Views:**

The creation of a destination resort at Pelican Hill also serves as a means of enhancing inland views. The combination of Planning Areas PA 13A, PA 13B, PA 13C, PA 13D, PA 13E, and PA 13F as an integral component of the golf course/visitor-serving complex provides the development basis for shifting residential areas off the Pelican Hill foreslopes onto the Pelican Hill ridgetop. Thus, the shift in land use from estate residential uses, contained in the 1981 Irvine Coast Land Use Plan, to a destination resort makes it feasible to locate the golf course/greenbelt so that it enhances much of the inland coastal viewshed.

e. **Traffic Benefits Deriving From Visitor-Support Facilities:**

The location of visitor-serving facilities in the Pelican Hill and Lower Wishbone areas will decrease traffic impacts on local communities by providing convenient overnight/resort visitor-serving facilities for users of Crystal Cove State Park. Park users would otherwise be forced to find accommodations in Laguna Beach or Newport Beach, thus driving through those communities on their way to and from the State Park. The provision of extensive day-use facilities will also diminish automobile traffic movement by providing food and other services readily available to park users. By concentrating development at the Pelican Hill and Lower Wishbone Canyon locations, the use of existing transit facilities operating between Laguna Beach and Newport Beach along Pacific Coast Highway will be encouraged and enhanced. The destination resort concept further reduces traffic impacts by providing a wide range of on-site recreational amenities. Traffic generation figures obtained from comparable destination resorts and set forth in the "Irvine Coastal Area Traffic Study" (February, 1987; see Appendices 3 & 4) indicate a much lower trip generation profile than for individual hotels. Shuttle service provided as part of normal hotel operations will also help to decrease new trips between John Wayne Airport and the site.

2. PUBLIC ACCESS

In furtherance of Coastal Act Section 30223, over 1,083 acres in Buck Gully and Los Trancos and Muddy Canyons will be committed to public recreational use and habitat protection. Public trails will connect Buck Gully and Los Trancos and Muddy Canyons to the State Park beach access trails, thereby enhancing public access, consistent with Coastal Act Sections 30213 and 30214, previously provided through the sale of the coastal shelf lands to the State Department of Parks and Recreation. As a result, the public will be provided with a rich diversity of recreational experiences, ranging from the pristine, secluded canyon setting of Los Trancos, to a sense of arrival at the ocean. Public views of the ocean will be provided from a park on a high knoll in Los Trancos, a public vista turn-out off Newport Coast Drive, and from public trails. Finally, the new trail system will provide significant up-coast and down-coast views as it links with the vista point on the new trail in front of Pelican Point.

3. RESIDENTIAL USES

Consistent with the requirements of Coastal Act Section 30250, residential areas have been located "contiguous with (and) in close proximity to, existing developed areas able to accommodate it". Development has been clustered in the areas of The Newport Coast in close proximity to existing residential areas and near existing employment centers. In furtherance of Coastal Act Section 30240(b), residential development has been clustered on the ridges away from sensitive habitat areas in the canyon bottoms.

4. CIRCULATION

The construction of the arterial highway system will be phased in order to meet traffic demands generated by development of The Newport Coast. In addition, roadway capacity beyond the needs attributable to development of The Newport Coast will be provided and will enhance public access to coastal recreation areas while mitigating any off-site transportation impacts.

Newport Coast Drive will provide access to the visitor-serving and public park facilities, and relieve congestion on Pacific Coast Highway and other coastal access routes located northerly

and southerly of The Newport Coast. In a regional context, this road becomes a direct access route for inland-generated traffic to the recreation areas of The Newport Coast.

By connecting the State Park entry at Pelican Point to the coastal hills, and joining MacArthur Boulevard¹ south of the University of California at Irvine campus, it reduces the need to use Pacific Coast Highway as a distribution route for inland traffic that would otherwise come from MacArthur Boulevard and Laguna Canyon Road. In particular, Newport Coast Drive in effect increases PCH capacity through Corona del Mar by providing a direct link between down-coast residential areas and major inland destinations, including employment centers and the UCI campus.

Because recreational traffic and commuter traffic generally flow in opposite directions in the morning and evening (i.e., morning commuter traffic flows toward the inland employment centers, while morning recreational traffic flows toward the coast; with reversed flow patterns in the evening), Newport Coast Drive will provide significant new recreational access capacity.

In addition to its recreational access function, Newport Coast Drive will provide direct access from The Newport Coast to the commercial centers of Orange County. It will have capacity well in excess of that required to accommodate the development of The Newport Coast, and as a result will reduce traffic levels through Corona del Mar.

Thus, the circulation improvements provided for in The Newport Coast LCP provide sufficient capacity to "accommodate needs generated by development", consistent with the requirements of Coastal Act Section 30254, while at the same time enhancing public recreational access.

¹ The San Joaquin Hills Transportation Corridor (SJHTC) was finally approved and the design contract awarded for it within the last seven years. It now encompasses part of Bonita Canyon Road and Newport Coast Drive outside of the coastal zone boundary. When completed, the SJHTC will constitute the direct link with MacArthur Boulevard and provide overall traffic benefits for the region not assumed in the approval of the original LCP. The County MPAH also maintains an alternative, non-tolled connection with Bonita Canyon Road, Ford Road, and MacArthur Boulevard.

CHAPTER 3

RESOURCE CONSERVATION AND MANAGEMENT POLICIES

This Chapter sets forth policies for the conservation and management of resources within The Newport Coast Planned Community. Policies are organized in the following sequence:

- A phased dedication program for 2,666 acres of public "wilderness" open space and interim management policies during program implementation;
- A dedication program for approximately 1,176 acres of public "special use" open space;
- Recreation/open space management policies for The Irvine Coast Wilderness Regional Park, as well as for other open space/passive recreation areas within the community;
- Policies related to the four different types of Environmental Sensitive Habitat Areas (ESHA's) within The Newport Coast;
- Specific programs for the protection of cultural (archaeological and paleontological) resources; and
- Policies to protect resources from erosion, sedimentation, and runoff, and to guide grading and the treatment of the interface edge between development and open space, including fuel modification programs required for fire safety.

A. DEDICATION PROGRAM REQUIREMENTS AND PROCEDURES

1. WILDERNESS OPEN SPACE

The landowner shall dedicate Planning Areas PA 18, PA 19, PA 21A, PA 21B, PA 21C, and PA 21D to the County of Orange as development of residential and commercial areas occurs, in accordance with the following policies and procedures.¹

¹ Irrevocable Offer of Dedication recorded November 10, 1988.

a. **Lands to be Dedicated:**

The Dedication Area includes approximately 2,666 acres in Planning Areas PA 18, PA 19, PA 21A, PA 21B, PA 21C, and PA 21D. In order to facilitate resource management, public access and acceptance by the County of portions of the dedication in phases, the Dedication Area has been divided into four Management Units. Acceptance by Designated Offerees of Management Units shall occur in numerical sequence as shown on Exhibit I. "Designated Offerees" are those agencies and organizations described in Subsection b-3) below.

In order to accommodate open space management objectives and the topographic characteristics of the Dedication Area, minor adjustments to the boundaries of the Management Units may be made by agreement of the landowner, the County, and the Coastal Commission and shall be treated as a minor amendment to this Plan at the direction of the Executive Director of the Commission.

b. **Procedures for Conveyance of Title:**

1) **Recordation of the Offer**

- a) **Timing of Recordation:** No later than ten (10) working days following the later of the following two events (1) the expiration of all statutes of limitation applicable to a legal challenge to certification of the LCP and the approval of a Development Agreement or "other mechanism" (as described below) by the County and the landowner, without any legal challenge having been filed, and (2) the date when both the foregoing certification and approval have become effective, the landowner shall record an Offer of Dedication for a term of thirty (30) years for the entire 2,666-acre Dedication Area. The term "or other mechanism" means that if County or landowner determines not to enter into a Development Agreement, then an "other mechanism" providing equivalent assurances of certainty of development will be entered into between the County and landowner as a condition precedent to the recording of the offer; upon entering into such an

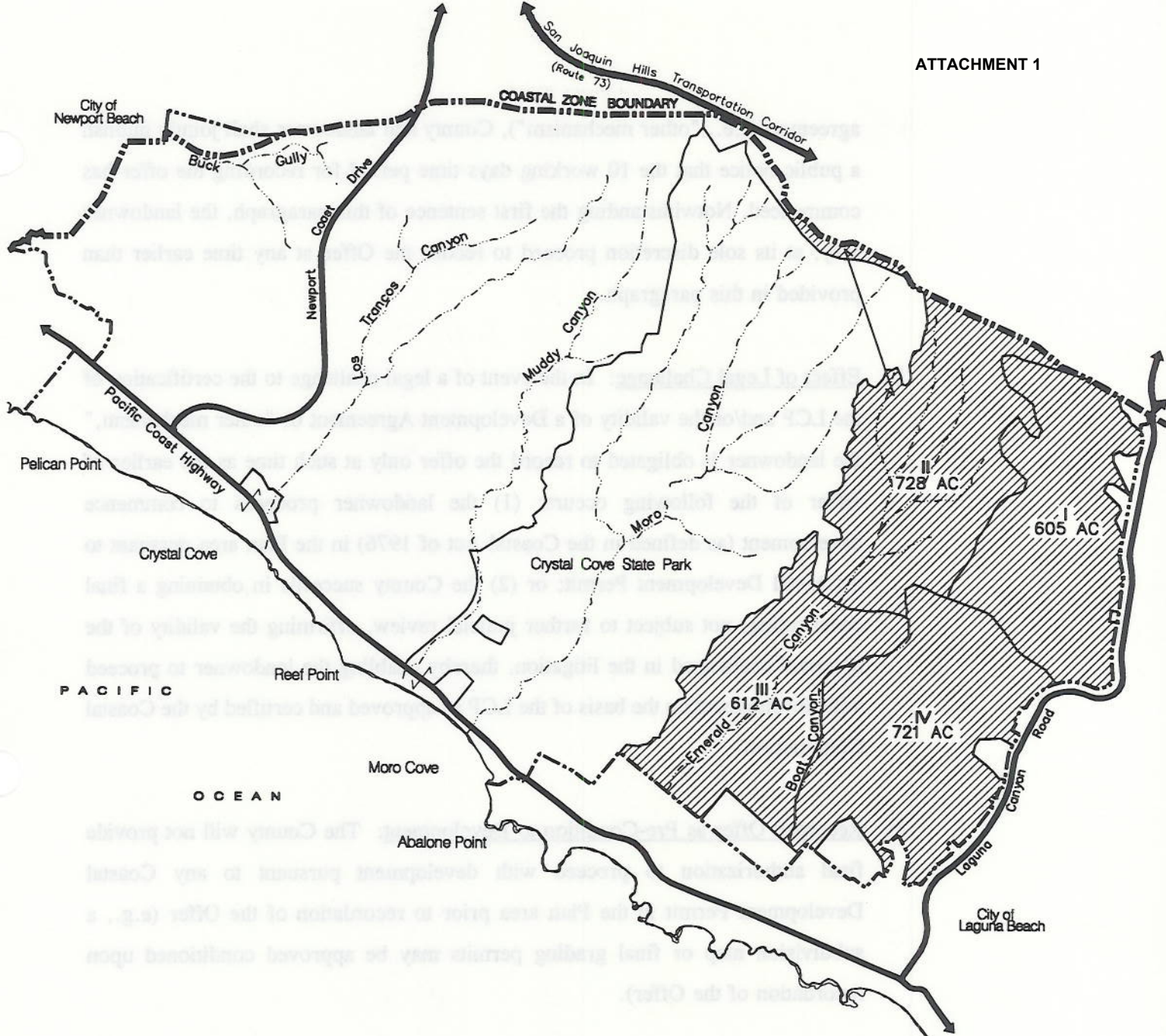

WILDERNESS DEDICATION AREA - Second Amendment

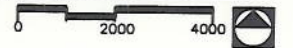

The Newport Coast Local Coastal Program

Exhibit I



December 3, 1986

LEGEND

-  MANAGEMENT UNIT AND SEQUENCE NUMBER
-  COASTAL ZONE BOUNDARY
-  PLANNED COMMUNITY BOUNDARY

agreement (i.e., "other mechanism"), County and landowner shall jointly publish a public notice that the 10 working days time period for recording the offer has commenced. Notwithstanding the first sentence of this paragraph, the landowner may, at its sole discretion proceed to record the Offer at any time earlier than provided in this paragraph.

- b) Effect of Legal Challenge: In the event of a legal challenge to the certification of the LCP and/or the validity of a Development Agreement or "other mechanism," the landowner is obligated to record the offer only at such time as the earlier of either of the following occurs: (1) the landowner proceeds to commence development (as defined in the Coastal Act of 1976) in the Plan area pursuant to a Coastal Development Permit; or (2) the County succeeds in obtaining a final court ruling, not subject to further judicial review, affirming the validity of the approval challenged in the litigation, thereby enabling the landowner to proceed with development on the basis of the LCP as approved and certified by the Coastal Commission.
- c) Recorded Offer as Pre-Condition to Development: The County will not provide final authorization to proceed with development pursuant to any Coastal Development Permit in the Plan area prior to recordation of the Offer (e.g., a subdivision map or final grading permits may be approved conditioned upon recordation of the Offer).

2) **Timing of Acceptance of Dedication Offer**

The Offer of Dedication will provide that the title for each Management Unit shall be automatically conveyed upon acceptance, as specified in Section "a)" above and in Section "b)(3)" below, as follows:

- a) Management Unit I may be accepted only after the issuance of the first grading permit authorizing (initial) grading in any residential, commercial, or golf course

planning areas (as identified in Exhibit E) other than for a Coastal Development Permit providing for the construction of Newport Coast Drive; and

b) One remaining Management Unit may be accepted only in numerical sequence and only as follows for each of the development increments listed below:

(1) Ninety days following issuance of building permits for a cumulative total of 1,000 primary residential dwelling units;

(2) Ninety days following issuance of building permits for a cumulative total of 2,000 primary residential dwelling units; and

(3) Ninety days following issuance of building permits for (a) a cumulative total of 1,500 overnight/resort accommodations (as defined in LUP Subsection 4-A-1-a and 4-A-2-a and in accordance with the intensity formula specified in LUP Subsection 4-A-1-b-4) or (b) a cumulative total of 80 percent of the 2.66 million square feet of development allowed in PA 13 (pursuant to LUP Chapter 4-A-1-b), whichever first occurs.

3) Designated Offerees

At such time as any Management Units may be accepted as provided in Subsection b-2)-a) or b-2)-b) above, the County of Orange, acting on its own behalf or through its designee(s), will have three (3) years to accept the Offer of such Management Unit(s), after which time the State of California either through the California Department of Parks and Recreation or the California Coastal Conservancy will have three (3) years to accept the Offer of Dedication. If the aforementioned public agencies have not accepted the Offer as specified, the Trust for Public Land or the National Audubon Society will have one (1) year to accept the Offer of Dedication. If none of these public or non-profit entities has accepted title to the Management Unit(s) within these timeframes, the Executive Director of the California Coastal Commission, following consultation with the County, shall be entitled to nominate, no later than ninety (90)

days thereafter, another non-profit entity as a Designated Offeree; the alternative non-profit entity nominated by the Executive Director may become a Designated Offeree only if determined to be mutually acceptable to the Coastal Commission, the County, and the landowner, and shall thereafter be required to accept the Offer(s) within six (6) months of the landowner's determination of acceptability. In the event that the Executive Director of the California Coastal Commission designates such alternative non-profit entity, none of the aforementioned parties shall unreasonably withhold approval of that entity, provided that it has the demonstrated financial capacity and management experience to undertake management of the dedication area in question. If, pursuant to the foregoing procedures, none of the public or non-profit entities has accepted said Offer(s) within these timeframes, the landowner will regain full title and unencumbered use of the offered land constituting the Management Unit(s) subject to LCP land use designations; provided that the landowner may seek an LCP amendment regarding future use(s) of these lands.

4) **Effects of Legal Action Preventing Development and Proportional Dedication**

- a) Acceptance Conditioned on Vesting: Acceptance of the four Management Units identified in the Offer of Dedication pursuant to Subsection b)-2) above, will be qualified by the requirement that the conveyance of title shall not occur if the landowner is prevented from vesting the right to develop the cumulative residential dwelling unit/overnight/resort accommodation levels as specified in Subsection b)-2) above by operation of federal, State or local law, or by any court decision rescinding, blocking or otherwise adversely affecting the landowner's governmental entitlement to develop said units. At any time that the landowner is subsequently entitled to proceed with development in the manner specified in the approved LCP, all dedication requirements and provisions shall be automatically reinstated provided that the term of the Offer has not been exceeded.
- b) Development Halted for Ten (10) Years: Notwithstanding the last sentence of Subsection a) above, if the landowner is prevented from proceeding with development (i.e., legally unable to undertake development for the reasons

identified in Subsection a) above) for an uninterrupted period of ten (10) years, the right to accept shall be suspended as it applies to the Management Unit(s) correlated with the type of development so halted (e.g., if the entitlement to develop overnight/resort accommodations has been halted for ten (10) years, the right of the Designated Offeree(s) to accept the Management Unit correlated with that development shall automatically be suspended). In such event, the right to undertake that type of development pursuant to the LCP shall likewise be suspended unless and until the landowner is legally authorized to proceed with that type of development previously halted. If the right to undertake any development pursuant to the LCP is halted as provided herein for a period of ten (10) years in any fifteen (15) year time period, the landowner shall have the right to terminate the Offer of Dedication and, in that event, the right to develop under the LCP shall automatically be suspended.

- c) Proportional Dedication: If the landowner has not been able to undertake the aforementioned development for a period of ten (10) years, the Designated Offeree(s) may only accept a proportional dedication in accordance with the following ratio:

Proportional Dedication — For each unit for which the landowner has received a certificate of occupancy, the Designated Offeree(s) may accept dedications in ratios of .76 acre for each such residential unit and .31 acre for each visitor accommodation unit or per each 1400 sq. ft. increment of the 2.66 million sq. ft. intensity allowed in PA 13 (whichever intensity level is achieved first).

Dedication areas accepted pursuant to the above proportional dedication requirement shall be located in accordance with the Management Unit sequencing identified on Exhibit I, with the precise location of the acreage to be contiguous with a previously accepted dedication area and/or adjacent to publicly owned park/open space land, and as specified by the accepting Designated Offeree(s) following consultation with the landowner.

d) Management Unit I Reversion: In the event that the landowner is prevented, as specified in Subsection 4)-a) above, from completing (i.e., receiving certificates of use and occupancy for) the first one thousand (1,000) primary residential dwelling units, title to any lands accepted by the Designated Offeree(s) in Management Unit I in excess of the Proportional Dedication ratio as applied to completed units shall revert to the landowner within six (6) months of the occurrence of the specified legal impediments to development.

5) Dedication Commitments – Effect of Landowner Delay in Development

a) Areas Graded but Not Completed: For any development area that has been graded and remained unimproved (i.e., without streets, infrastructure, and permanent drainage systems) for a period of five (5) years following the commencement of grading, the Designated Offeree(s) may accept a dedication area in accordance with the proportional dedication formula in Subsection 4)-c) above, with the application of the formula based on the number of development units specified/authorized in the Coastal Development Permit which served as the governmental authorization for the grading activity. This provision shall not apply where the delay in vesting development rights on the land area in question has occurred as a result of the operation of federal, State or local law, or by any court decision rescinding, blocking, or otherwise adversely affecting the landowner's governmental entitlement to develop the specified units on said land area.

b) Fifteen (15) Year Deadline for Completing All Dedications: All dedication increments that have not been eligible for acceptance pursuant to the provisions of Subsection 2) above may be accepted fifteen (15) years after the recording of the Offer of Dedication. Provided, however, that in the event the landowner is prevented from proceeding with development (i.e., unable to proceed voluntarily) by operation of federal, State, or local law, or by any court decision rescinding, blocking, or otherwise adversely affecting the landowner's governmental entitlement to develop, the fifteen (15) year timeframe for completing all acceptances of dedication increments shall be extended by a time period equal to

the amount of time the right to proceed with development has been suspended. This provision extending the fifteen (15) year time period shall not apply where the development project has been halted by a final, non-appealable court decision based upon the failure of the development project to comply with the certified LCP and/or CEQA. In the event the landowner becomes subject to a federal, State or local law, or any court decision which limits the allowable number of building permits which may be approved or issued each year (or within a given time period), the fifteen (15) year time frame for completing all acceptances of dedication increments shall be extended by a time period equal to the amount of time necessary for the landowner to obtain the maximum allowed building permits per year to complete the total development by the LCP; if the foregoing extension of the fifteen (15) year time period would exceed the term of the Offer, the landowner may either extend the term of the Offer or allow the Offer and any remaining entitlement at that time pursuant to the LCP to expire.

6) Acceptance of Dedication Increments

The acceptance of dedication increments shall be conditioned on a requirement that the dedication lands may be used only for purposes consistent with land uses allowed in the certified LCP and may be conveyed subsequent to the initial acceptance only to other Designated Offerees.

7) Dedication Area Access

Access to the dedication areas prior to any acceptance shall be limited to the County or other Designated Offeree (in the event that County's acceptance period for a particular Management Unit(s) has expired), its employees, licensees, representatives, and independent contractors acting within the scope of their employment by the County or other Designated Offeree solely for the purposes of surveying, mapping and planning activities related to future management of the dedication areas. Any such access shall be subject to landowner entry permit requirements regarding personal liability and personal security.

8) Property Description

A detailed property description for each Management Unit shall be set forth in the Offer of Dedication.

2. SPECIAL USE OPEN SPACE

The landowner shall dedicate Planning Areas PA 11A, PA 12A, PA 12E, PA 12H and PA 12I to the County of Orange and PA 12G to the California Department of Parks and Recreation or the County of Orange as development of abutting residential areas occurs. The landowner shall receive local park credit for not less than five (5) acres of special use open space dedication. Area(s) designated as special use park shall be made separate parcels suitable for transfer to any succeeding city or local park operating agency in accordance with the following policies and procedures.

- a. Prior to or concurrent with the recordation of the first final development map, other than a large-lot subdivision in PA 1A, PA 1B, or PA 2A, the landowner shall record an Offer of Dedication for PA 11A¹.
- b. Prior to or concurrent with the recordation of the first final development map, other than a large-lot subdivision in PA 1C, PA 2B, PA 2C, PA 5, PA 4A, or PA 3A, the landowner shall record an Offer of Dedication for PA 12A¹.
- c. Prior to or concurrent with the recordation of the first final development map, other than a large-lot subdivision in PA 4A, PA 4B, PA 5, or PA 6, the landowner shall record an Offer of Dedication for PA 12E.
- d. Prior to or concurrent with the recordation of the first final development map, other than a large-lot subdivision in PA 7A, the landowner shall record an Offer of Dedication for PA 12H.

¹ Planning Areas PA 11A (Buck Gully) and PA 12A (Los Trancos Canyon) have been irrevocably offered to the County of Orange for dedication.

- e. Prior to or concurrent with the recordation of the first final development map, other than a large-lot subdivision in PA 7B, the landowner shall record an Offer of Dedication for PA 12I.
- f. Prior to or concurrent with the recordation of the first final development map, other than a large-lot subdivision in PA 6, the landowner shall record an Offer of Dedication for PA 12G to the California Department of Parks and Recreation or the County of Orange which includes rights for both agencies to access their respective park properties¹.
- g. The above offers shall be irrevocable continuing offers of dedication to the County of Orange or its designee for park purposes in a form approved by the Manager, EMA-Harbors, Beaches and Parks/Program Planning Division, suitable for recording fee title. The offers shall be free and clear of money and all other encumbrances, liens, leases, fees, easements (recorded and unrecorded), assessments and unpaid taxes in a manner meeting the approval of the Manager, EMA Harbors, Beaches and Parks Program Planning Division. The offers shall be in a form that can be accepted for transfer of fee title at any time by the County.
- h. Notwithstanding the above procedures, offers of dedication may be made in a Parcel A and Parcel B sequence. Parcel A shall contain, to the greatest extent possible, the area to be included in the dedication and shall be offered for dedication at the time specified in Subsection a, b, and c above. The boundaries of Parcel A shall be determined through a review of the physical characteristics of the total planning area required for dedication excluding only those areas where the boundary for public open space cannot feasibly be determined until final development maps are processed. The boundaries of Parcel B shall be refined and offered for dedication upon the recordation of subsequent final maps for planning areas abutting the area to be dedicated. When appropriate, areas containing urban edge treatments, fuel modification areas, roads, manufactured slopes, and similar uses may be offered for dedication as scenic easements.

¹ Planning Area 12G may be offered for dedication to the California Department of Parks and Reception as part of a future agreement to offset any acreage reductions within Crystal Cove State Park used to expand the facilities at El Morro Elementary School.

B. INTERIM CONSERVATION MANAGEMENT POLICIES

Most of the Conservation lands are currently under private ownership and will be transferred in increments to a public agency over time. Prior to transfer, the landowner will be responsible for maintenance and management of these lands.

The following policies provide an interim management program which will preserve natural resources for future public stewardship in an economically sound manner by maintaining the lands in their current condition. Notwithstanding the provisions of the Conservation category, the following policies shall apply to lands designated Conservation while they remain in private ownership. No new development will occur, except for improvements to existing facilities, new fences, and fire, flood and erosion control facilities and as provided below:

1. The landowner may continue existing agriculture uses including cattle grazing and may construct and maintain any fencing, firebreaks, fuel modification zones, water pipes, cattle-watering facilities, and access roads necessary for the continued use and protection of the property.
2. New fences will be designed so that wildlife, except large mammals such as deer, can pass through.
3. No alteration to existing stream courses or landforms in Emerald Canyon will occur except as necessary to provide fire protection.
4. No excavations of archaeological and paleontological sites will be permitted except as required by public safety and/or utilities facilities and in accordance with the policies set forth in Sections G and H of this chapter.
5. Landform alterations are allowed in the Conservation Area to the extent required to accommodate realignment, improvement, and/or widening of Laguna Canyon Road and associated improvements and shall conform with the requirements of LUP Section I-4-E-20 for any such project.
6. No agricultural practice shall aggravate known or suspected land management problems such as the spread of non-native plants, soil erosion, or the deterioration of sensitive environmental habitats.

C. RECREATION/OPEN SPACE MANAGEMENT POLICIES

1. Irvine Coast Wilderness Regional Park (PA 18, PA 19, PA 21A, PA 21B, PA 21C, and PA 21D)

The Newport Coast open space system will be preserved through the Conservation and Recreation land use designations and implementing policies. The intent of these land use categories is consistent with the Orange County General Plan's "Recreation Element" (REC) which assigns wilderness regional park status to The Irvine Coast Wilderness Open Space dedication area.

The Recreation Element defines "wilderness regional park" as:

"A regional park in which the land retains its primeval character with minimal improvements and which is managed and protected to preserve natural processes. The park, (1) generally appears to have been affected primarily by forces of nature, with the imprint of man's work substantially unnoticeable; (2) has outstanding opportunities for solitude or a primitive and unconfined type of recreation; (3) is of sufficient size as to make practicable its preservation and use in an unimpaired condition; and (4) may also contain ecological, geological, or other features of scientific, educational, scenic or historical value."

The Orange County General Plan's "Recreation Element" contains the resource management and development policy for such wilderness regional park facilities which is incorporated into this Local Coastal Program. The policy (REC, p.4-8) permits, (1) only restricted hardscape and domestication appropriate to provide access and enjoyment/observation of natural resources and processes, (2) interpretive programs, and (3) park concessions. Park concessions within PA 18 and PA 19 will be limited to uses which support passive recreation activities such as riding, hiking, picnicking, and camping, and may be operated as a regional park concession by a limited commercial venture under contract to the public agency.

Additional land use policies for subareas within the wilderness regional park are applicable to each specific planning area as follows:

a. Planning Area PA 18 (Upper Emerald Canyon):

- 1) Principal permitted use includes riding and hiking trails, picnicking, and passive recreation facilities such as viewpoints and rest stops.
- 2) Except for emergency and maintenance vehicles, vehicles will be prohibited in the canyon bottom.
- 3) Where feasible, trails and roads will incorporate existing trails and roads.
- 4) No more than one (1) percent of the total land area will be developed with structures, pavement, or other impervious materials.
- 5) Stream courses in Emerald Canyon and significant riparian vegetation will be maintained or enhanced.

b. Planning Area PA 19 (Upper Emerald Ridge):

- 1) Principal permitted use includes parking associated with park use, tent camping, stables, youth hostels, riding and hiking trails, and picnicking.
- 2) Where feasible, trails and roads will incorporate existing trails and roads.
- 3) Access roads will be limited to two lanes.
- 4) No more than 10 percent of the total land area will be developed with structures, pavements, or other impervious materials.

- 5) Recreation improvements will allow wildlife movement across portions of Moro and Emerald Ridges.

c. Planning Areas PA 21A, PA 21B, PA 21C, and PA 21D:

- 1) Principal permitted use includes those uses which are of a passive recreational nature (such as viewpoints), of limited active recreational nature (such as riding and hiking trails), which are concerned with scientific study and interpretation, or involve public safety, facilities, and utilities.
- 2) Wildlife habitats will be preserved by controlling human access to Emerald and Moro Canyons.
- 3) Key areas of chaparral and coastal sage will be protected from human intrusion.
- 4) Stream courses in Emerald and Moro Canyons will be retained in a natural state or enhanced.
- 5) Significant riparian areas will be preserved as sources of shelter and water for wildlife.
- 6) Improvements will be compatible with the natural environment and will not damage landforms, vegetation, or wildlife to any significant degree.
- 7) All archaeological sites and paleontological sites will be preserved except sites impacted by public safety and/or utilities facilities.
- 8) Any buffer areas necessary for the protection of habitat are located within the Conservation category.
- 9) All existing trees will be preserved in Moro, Emerald, and Laguna Canyons except as required for new public trails, infrastructure, and/or roads.

- 10) Lands within 350 feet of Laguna Canyon Road and less than 30 percent slope may be used for trail heads, recreation staging areas, public utilities, drainage, flood and erosion control facilities, and other similar public uses. Development of these areas for such uses shall not constitute a significant effect on landform, vegetation, or wildlife for purposes of Policy 2, 3, and/or 4 above.
- 11) Landform alterations are allowed in the Conservation Area to the extent required to accommodate realignment, improvement, and/or widening of Laguna Canyon Road and associated improvements and the requirements of LCP Subsection I-4-E-20 for any such project.
- 12) Access roads are permitted and will be limited to two lanes or a total of 20 feet in width. Where possible, trails and roads will use existing trails and roads (i.e., for park operations, maintenance, and emergency access vehicles).

2. **Buck Gully, Los Trancos/Muddy Canyons, and Pelican Hill Areas**

In addition to the Wilderness Open Space Dedication Area (Irvine Coast Wilderness Regional Park), environmentally sensitive areas within the development zone except for the ESHA B located within Planning Area 4A, including Buck Gully, Los Trancos and Muddy Canyons, and portions of the Pelican Hill frontal areas will be preserved in open space, with opportunities for "special use" recreation within Planning Areas PA 11A, PA 12A, and PA 12E.

a. **Planning Areas PA 11A and PA 11B (Buck Gully and the frontal slopes of Pelican Hill):**

- 1) Principal permitted use includes passive parks, riding and hiking trails, bikeways, drainage control facilities, water and sewer facilities, access and maintenance roads, and utilities.

- 2) Recreation lands in PA 11A shall be dedicated to, and owned and maintained by, the County of Orange or other designated public agency. Recreation lands in PA 11B may be owned and maintained by homeowner associations, adjoining property owners, special assessment districts, the County of Orange and/or other appropriate public agencies.
- 3) Residential lot lines from adjoining properties may extend into PA 11B, but not into PA 11A.
- 4) Natural landforms will be retained by locating recreational facilities in the flatter portions of the canyon bottom, and so as not to interfere with natural stream courses or riparian vegetation.
- 5) A maximum of 2% of the total lands designated in PA 11A and PA 11B category may be developed with impervious surfaces (i.e., trails, roads, recreation facilities, etc.).
- 6) Recreational facilities to be considered for Local Park credit will be located on finished grade slopes generally less than 30%.
- 7) Except for emergency and maintenance vehicles, vehicular access will be prohibited.
- 8) Archaeological and paleontological sites will be preserved except where necessary to provide public safety and/or utilities facilities.

b. Planning Areas PA 12A, PA 12B, PA 12C, PA 12D, PA 12E, PA 12H and PA 12I (Los Trancos/Muddy Canyons, the frontal slopes of Lower Wishbone and North Laguna):

- 1) Principal permitted use includes passive parks (except in PA 12C, where limited active recreational uses are permitted), riding and hiking trails, bikeways, drainage control facilities, water and sewer facilities, access and maintenance roads, utilities, parking and staging areas.

- 2) Recreation lands in PA 12A, PA 12E, PA 12H and PA 12I shall be dedicated to, and owned and maintained by the County of Orange. Recreation lands in PA 12B, PA 12C, and PA 12D may be owned and maintained by homeowner associations, adjoining property owners, special assessment districts, the County of Orange and/or other appropriate public agencies.
- 3) A maximum of 1% of the total lands in PA 12A, PA 12D, PA 12E and PA 12I may be developed with impervious surfaces (i.e., structures, roads, recreation facilities, etc.).
- 4) A maximum of 12% of the total land area in PA 12B, PA 12C and in PA 12H may be developed with structures, pavement or other impervious materials.
- 5) Recreational facilities to be considered for Local Park credit will be located on finished grade slopes generally less than 30%.
- 6) Archaeological and paleontological sites will be preserved except where necessary to provide public safety and/or utilities facilities.
- 7) Local roads and associated infrastructure connecting PA 3A, PA 3B, PA 4A, and PA 4B will be permitted through PA 12B.
- 8) Landform alterations are allowed in PA 12A, PA 12B, PA 12C, PA 12D and PA 12E to the extent required to accommodate realignment and construction of local collector roads, San Joaquin Hills Road, and/or the San Joaquin Hills Transportation Corridor and recreational facilities, as provided in a final Coastal Development Permit for any such projects.
- 9) Residential lot lines from adjoining properties may extend into PA 12B, PA 12C, and PA 12D, but not into PA 12A, PA 12E, PA 12H or PA 12I.

D. CATEGORY "A" & "B" ENVIRONMENTALLY SENSITIVE HABITAT AREA POLICIES

The following policies apply to Category A and B ESHA's only, as delineated on Exhibit H.

1. Except for the ESHA B located in Planning Area 4A, the natural drainage courses and natural springs will be preserved in their existing state. All development permitted in Category A and B ESHA's shall be set back a minimum of 50 feet from the edge of the riparian habitat except as provided for in the following subsections. If compliance with the setback standards precludes proposed development which is found to be sited in the least environmentally damaging and feasible location, then the setback distance may be reduced accordingly.
 - a. Where existing access roads and trails cross streams, where emergency roads are required by State or County fire officials, and/or where access roads are required to serve residential units and recreational facilities in Muddy Canyon, the drainage course may be modified to allow the construction and maintenance of existing or new road or trail crossings. Such modification shall be the least physical alteration required to maintain an existing road or to construct a new road or trail, and shall be undertaken, to the extent feasible, in areas involving the least adverse impact to stream and riparian habitat values.
 - b. Where drainage and erosion control and related facilities are needed for new development and/or to protect the drainage course, the drainage course may be modified to allow construction of such facilities. Modification shall be limited to the least physical alteration required to construct and maintain such facilities, and shall be undertaken, to the extent feasible, in areas involving the least adverse impact to the drainage course. Where feasible, drainage and erosion control and related facilities will be located outside the drainage course.
 - c. Where the construction requires filling or other modification of drainage courses substantially as shown in Exhibit L , drainage courses may be modified.

- d. Where the construction of local collectors, and/or utility service/emergency access roads requires filling or other modifications of drainage courses in PA 6, PA 12C, and/or the upper portion of PA 12A and where the alignment is shown to be the least environmentally damaging feasible alternative, drainage courses may be modified.
 - e. Where access roads and trails exist or where new emergency roads are required by State or County fire officials, vegetation may be removed in the maintenance or construction of such roads and trails. Any required vegetation removal will be minimized.
 - f. To the extent necessary, existing riparian vegetation may be thinned or selectively removed when required for habitat enhancement and/or fire control. Existing vegetation which is not classified as riparian may also be removed.
 - g. Where drainage and erosion control and related facilities are needed to implement the Master Drainage and Runoff Management Plan and related programs, vegetation may be removed in the construction and maintenance of such facilities. Vegetation removal will be limited to the least required to construct and maintain such facilities and shall be undertaken, to the extent feasible, in areas involving the least adverse impact to riparian vegetation. Where feasible, drainage and erosion control and related facilities will be located outside areas containing riparian vegetation.
 - h. Upon the recordation of an Offer of Dedication for Planning Area 12E, the ESHA B located in Planning Area 4A may be altered as required for development authorized by this LCP.
2. Where feasible, the separation of scrub and chaparral from riparian habitats will be avoided. Vegetation offering escape cover will be allowed adjacent to riparian areas wherever feasible.
 3. Nothing in this section shall require the replacement or restoration of natural features which are destroyed or modified by natural causes such as fire, flood, erosion, and drought.

4. Where golf cart and pedestrian path/bridge, and fairway trajectories for the golf course cross the USGS Drainage Course in PA 10B, vegetation may be selectively thinned, maintained, removed and/ or altered within areas of the setback to the extent necessary for golf course purposes. Any such vegetation removal or alteration will be minimized and mitigated by habitat enhancement measures in Los Trancos Canyon, and will be shown to be the least environmentally damaging feasible alteration.

E. CATEGORY "C" ENVIRONMENTALLY SENSITIVE HABITAT AREA POLICIES

The Category C ESHA, as delineated in Exhibit H, contains coastal waters which have been designated a Marine Life Refuge and an Area of Special Biological Significance.

The Category C ESHA area is encompassed within Crystal Cove State Park. The protection of water quality in marine resource areas is subject to the authority of the State Water Resources Control Board. Protection of water quality is provided by the LCP Runoff Policies and will be reviewed by the Regional Water Quality Control Board in conjunction with subsequent coastal development permits and related environmental impact reports (EIR's).

A water quality monitoring program shall be submitted to the Regional Water Quality Control Board prior to initial implementing approvals for the golf course, for the purpose of monitoring runoff entering the ocean as well as the riparian corridors¹. Copies of the results of the monitoring program shall be forwarded to the Regional Water Quality Control Board and the County of Orange on a regular basis for their review to determine whether corrective action is required pursuant to the authority of said agencies.

Use and application of chemicals on the golf course and other landscape areas shall be limited to those approved by State, County, and Federal agencies. The landowner shall be responsible for notifying tenants and/or prospective initial purchasers of this requirement.

¹ The five-year Water Quality Monitoring Program began in 1991. To date, the monitoring results indicated no adverse water quality impacts on local marine waters.

F. CATEGORY "D" ENVIRONMENTALLY SENSITIVE HABITAT AREA POLICIES

1. PA 10A: All drainage courses will be modified. The Riparian Habitat Creation Program will mitigate any habitat values lost as a result of drainage course modification.
2. PA 1A, PA 1B, PA 1C, PA 2A, PA 2B, PA 2C, PA 3A, PA 3B, PA 4A, PA 4B, PA 6, PA 8, PA 9, PA 10A, PA 10B, PA 11A, PA 12A, PA 12B, PA 12C, PA 12D, PA 12E, PA 12F, PA 12G, PA 12H, PA 12I, PA 12J, PA 13A, PA 13B, PA 13C, PA 13D, PA 13E, PA 13F, PA 14, PA 16A, PA 16B, PA 20A, PA 20B, and PA 20C: Vegetation and drainage courses will be modified or eliminated by development. The Open Space Dedication Programs and Riparian Habitat Creation Program will mitigate any habitat values lost as a result of such drainage course modification or elimination.
3. Construction of Newport Coast Drive, local collectors, and San Joaquin Hills Transportation Corridor will modify or eliminate vegetation and drainage courses.

G. ARCHAEOLOGICAL POLICIES

1. ARCHAEOLOGICAL RECORDS SEARCH AND SURVEY

Prior to initial implementation level approvals (i.e., Coastal Development Permit, Tentative Tract, Site Plan, etc., with the exception of a large-lot subdivision for only financial/conveyance purposes), a County certified archaeologist shall be retained by the applicant to complete a literature and records search for recorded sites and previous surveys. In addition, a field survey shall be conducted by a County-certified archaeologist unless the entire proposed project site has been documented as previously surveyed in a manner which meets the approval of the Manager, County of Orange EMA - Harbors, Beaches and Parks/Program Planning Division. A report of the literature and records search and the field survey shall be submitted to and approved by the Manager, County of Orange EMA - Harbors, Beaches and Parks/Program Planning Division. Mitigation measures may be required depending upon the recommendations of this report.

2. ARCHAEOLOGICAL SUBSURFACE TEST AND SURFACE COLLECTION

Prior to the issuance of a grading permit, a County-certified archaeologist shall be retained by the applicant to perform a subsurface test level investigation and surface collection as appropriate. The test level report evaluating the site shall include discussion of significance (depth, nature, condition, and extent of the resources), final mitigation recommendations, and cost estimates. Prior to the issuance of a grading permit and based on the report recommendations and County policy, final mitigation shall be carried out based upon a determination as to the site's disposition by the Manager, County of Orange EMA - Harbors, Beaches and Parks/Program Planning Division. Possible determinations include, but are not limited to, preservation, salvage, partial salvage or no mitigation necessary.

3. ARCHAEOLOGICAL SALVAGE

If salvage or partial salvage is determined necessary by the Manager, County of Orange EMA - Harbors, Beaches and Parks/Program Planning Division per subsection 2 above, prior to issuance of a grading permit, project applicant shall provide written evidence to the Chief, EMA-Regulation/Grading Section that a County-certified archaeologist has been retained to conduct salvage excavation of the archaeological resources in the permit area. A final report shall be submitted to and approved by the Manager, County of Orange EMA - Harbors, Beaches and Parks/Program Planning Division prior to any grading in the archaeological site areas.

4. ARCHAEOLOGICAL RESOURCE SURVEILLANCE

If on-site resources surveillance is determined necessary during grading per subsection 2 above by the Manager, Harbors, Beaches and Parks/Program Planning Division, prior to issuance of a grading permit, the project applicant shall provide written evidence to the Chief, EMA-Regulation/Grading Section that a County-certified archaeologist has been retained, shall be present at the pre-grading conference, shall establish procedures for archaeological resource surveillance, and shall establish, in cooperation with the project developer, procedures for temporarily halting or redirecting work to permit the sampling, identification, and evaluation

of the artifacts as appropriate. If additional or unexpected archaeological features are discovered, the archaeologist shall report such findings to the project developer and to the Manager, County of Orange EMA - Harbors, Beaches and Parks/Program Planning Division. If the archaeological resources are found to be significant, the archaeological observer shall determine appropriate actions, in cooperation with the project developer, for exploration and/or salvage. These actions, as well as final mitigation and disposition of the resources, shall be subject to the approval of the Manager, County of Orange EMA - Harbors, Beaches and Parks/Program Planning Division.

Except as may be limited by a future Coastal Development Permit, on-site resource surveillance shall be provided for development grading operations in Planning Areas PA 3A, PA 3B, PA 10A, PA 10B, PA 13A, PA 13B, PA 13C, PA 13D, PA 13E, PA 13F, and PA 14.

H. PALEONTOLOGICAL POLICIES

1. PALEONTOLOGICAL RECORDS SEARCH AND SURVEY

Prior to initial implementation level approvals (i.e., Coastal Development Permit, Tentative Tract, Site Plan, etc., with the exception of a large-lot subdivision map for financial conveyance purposes), a County-certified paleontologist shall be retained by the applicant to complete literature and records search for recorded sites and previous surveys. In addition, a field survey shall be conducted by a County-certified paleontologist unless the entire proposed project site has been documented as previously surveyed in a manner which meets the approval of the Manager, County of Orange EMA - Harbors, Beaches and Parks/Program Planning Division. A report of the literature and records search and the field survey shall be submitted to and approved by the Manager, County of Orange EMA - Harbors, Beaches and Parks/Program Planning Division. Future mitigation shall depend upon the recommendations of this report.

2. PALEONTOLOGICAL PREGRADING SALVAGE

If pre-grading salvage is determined necessary per subsection 1 above by the Manager, County of Orange EMA - Harbors, Beaches and Parks/Program Planning Division, prior to issuance

of a grading permit, the project applicant shall provide written evidence to the Chief, EMA-Regulation/Grading Section that a County-certified paleontologist has been retained by the applicant to conduct preconstruction salvage of the exposed resources. The paleontologist shall submit a follow-up report on survey methodology and findings to the Manager, County of Orange EMA - Harbors, Beaches and Parks/Program Planning Division for review and approval.

3. PALEONTOLOGY RESOURCE SURVEILLANCE

If on-site resource surveillance is determined necessary per subsection 1 above by the Manager, County of Orange EMA - Harbors, Beaches and Parks/Program Planning Division, prior to issuance of a grading permit, the project applicant shall provide written evidence to the Chief, EMA-Regulation/ Grading Section that a County-certified paleontologist has been retained to observe grading activities and salvage fossils as necessary. The paleontologist shall be present at the pre-grading conference, shall establish procedures for paleontologist resource surveillance, and shall establish, in cooperation with the project developer, procedures for temporarily halting or redirecting work to permit sampling, identification, and evaluation of the fossils. If major paleontological resources are discovered, which require long-term halting or redirecting of grading, the paleontologist shall report such findings to the project developer and the Manager, County of Orange EMA - Harbors, Beaches and Parks/Program Planning Division. The paleontologist shall determine appropriate actions, in cooperation with the project developer, which ensure proper exploration and/or salvage. These actions, as well as final mitigation and disposition of the resources shall be subject to approval by the Manager, County of Orange EMA - Harbors, Beaches and Parks/Program Planning Division. The paleontologist shall submit a follow-up report for approval by the Manager, County of Orange EMA - Harbors, Beaches and Parks/Program Planning Division, which shall include the period of inspection, an analysis of the fossils found, and present repository of the fossils.

Except as may be limited by a future Coastal Development Permit, on-site resource surveillance shall be provided for development grading operations in Planning Areas PA 3A, PA 3B, PA 10A, PA 10B, PA 13A, PA 13B, PA 13C, PA 13D, PA 13E, PA 13F, and PA 14.

I. EROSION POLICIES

The Erosion Policies which follow provide the framework for the preparation of a "Master Drainage and Runoff Management Plan". This Plan shall be submitted to the County of Orange for review and approval concurrent with the first Coastal Development Permit application as required by LCP Subsection II-3-B-11¹.

1. Post-development erosion rates shall approximate the natural or existing rate before development.
2. Areas of disturbed soil shall be reseeded and covered with vegetation; mulches may be used to cover ground areas temporarily; other mechanical or vegetative techniques to control erosion may be used where necessary. Native and/or appropriate non-native plant material selected for vegetation shall be consistent with LCP Subsection I-3-L-6.
3. Erosion control devices shall be installed in coordination with clearing, grubbing, and grading of upstream construction; the Grading Plan shall describe the location and timing for the installation of such devices and shall describe the parties responsible for repair and maintenance of such devices.
4. Erosion control measures for grading and construction done during the period from April 15 to October 15 will be implemented by October 15 and maintained as necessary through April 15. For grading and construction commencing in the period from October 15 to April 15, erosion control measures will be implemented in conjunction with the project in a manner consistent with the County of Orange Grading Code. Erosion control measures for areas not affected by grading and construction are not required.
5. Where new recreational trails are planned in open space areas, they will be located and constructed to minimize erosion.

¹ A Master Drainage and Runoff Management Plan was approved by the County of Orange in December, 1989. Amendments will be prepared for all future development projects located outside the area covered by this Master Plan.

J. SEDIMENT POLICIES

The Sediment Policies which follow provide the framework for the preparation of a "Master Drainage and Runoff Management Plan". This Plan shall be submitted to the County of Orange for review and approval concurrent with the first Coastal Development Permit application as required by LCP Subsection II-3-B-11¹.

1. Required sediment basins (e.g., debris basins, desilting basins, and/or silt traps) shall be installed in conjunction with the initial grading operations and maintained through the development/construction process to remove sediment from runoff.
2. To prevent sedimentation of off-site areas, on-site vegetation shall be maintained where feasible. Vegetation shall be replanted from seed/hydroseed to help control sedimentation where necessary. Native and/or appropriate non-native plant material selected for vegetation shall be consistent with LCP Subsection I-3-L-6.
3. Temporary mechanical means of controlling sedimentation such as hay bales, earth berms and/or sand-bagging around the site, may be used as part of an overall Erosion Control Plan, subject to County approval.
4. Sediment movement in the natural channels shall not be significantly changed in order to maintain stable channel sections and to maintain the present level of beach sand replenishment.
5. Sediment catch basins and other erosion control devices shall be designed, constructed and maintained in accordance with the County of Orange Grading Code.

¹ A Master Drainage and Runoff Management Plan was approved by the County of Orange in December, 1989. Amendments will be prepared for all future development projects located outside the area covered by this Master Plan.

K. RUNOFF POLICIES

The Runoff Policies which follow provide the framework for the preparation of a "Master Drainage and Runoff Management Plan". This Plan shall be submitted to the County of Orange for review and approval concurrent with the first Coastal Development Permit application as required by LCP Subsection II-3-B-11¹.

1. Peak flood discharge rates of storm water flows in the major streams shall not exceed the peak rates of storm water runoff from the area in its natural or undeveloped state, unless it can be demonstrated that an increase in the discharge of no more than 10% of the natural peak rate will not significantly affect the natural erosion/beach sand replenishment process.
2. Drainage facilities shall be designed and constructed in accordance with the County of Orange Flood Control District Design Manual.
3. Storm runoff water shall be directed to storm drains or suitable water courses to prevent surface runoff from damaging faces of cut and fill slopes.
4. Adequate maintenance of retention basins shall be assured as a precondition to the issuance of grading permits.
5. Natural drainageways will be rip-rapped or otherwise stabilized below drainage and culvert discharge points in accordance with County of Orange policies.
6. Runoff from development will be conveyed to a natural drainageway or drainage structure with sufficient capacity to accept the discharge.

¹ A Master Drainage and Runoff Management Plan was approved by the County of Orange in December, 1989. Amendments will be prepared for all future development projects located outside the area covered by this Master Plan.

L. GRADING POLICIES

1. Prior to implementation level development approvals (i.e., tentative tract, site plan, etc.), the applicant shall submit soils engineering and geologic (if appropriate due to slope conditions) studies as necessary to the Manager, County of Orange EMA Development Services Division (DSD). These reports will assess potential soil related constraints and hazards such as slope instability, settlement, liquefaction, or related secondary seismic impacts as determined appropriate by the DSD Manager. All reports shall recommend appropriate mitigation measures and be completed in the manner specified in the County of Orange Grading Manual and State/County Subdivision Ordinance. Pursuant to the Orange County Grading Code, the permit applicant shall provide a schedule showing when each stage and element of the project will be completed, including estimated starting and completion dates, hours of operation, days of week of operation, and the total area of soil surface to be disturbed during each stage of construction.
2. Grading allowed between October 15 and April 15 shall be subject to the Erosion, Sediment, Runoff, and Grading Policies herein and the provisions of the County of Orange Grading Code.
3. Temporary stabilization techniques may be used on areas which will be redisturbed during future construction. Permanent stabilization techniques must be used in all other areas.
4. Disposal of earthen materials removed during any development operations shall be as follows:
 - a. Top soil for later use in revegetation shall be stockpiled on the site in previously designated areas approved by the permit-issuing authority. Runoff from the stockpiled area shall be controlled to prevent erosion.
 - b. Other earthen material shall be disposed at locations approved by the permit issuing authority.
 - c. Except for necessary drainage improvements and/or erosion control modifications, no materials shall be placed within the 100 year flood-plain of coastal waters and/or streams.

5. Where construction activities during the rainy season would involve substantial foot or vehicle traffic, or stockpiling of materials in a manner that would prevent establishment of temporary vegetation, alternative temporary stabilization methods shall be used.
6. All cut and fill slopes in a completed development involving grading shall be stabilized through planting of native annual grasses and shrubs, or appropriate non-native plants valuable for erosion protection. All cut and fill slopes shall be planted under the direction of a licensed landscape architect, sufficient to provide a mixture of deep rooted permanent plants and nursery crops valuable for temporary stabilization.
7. Removal of natural vegetation will be limited to graded areas, access/haul roads, and areas required for fuel modification. Construction equipment shall be limited to the approved area to be disturbed except for approved haul roads.
8. All residential Planning Areas: The visual effect of grading required for housing will be minimized and/or mitigated by contouring as follows:
 - a. A smooth and gradual transition between graded and natural slopes will be maintained.
 - b. A variety of different slopes will be used to reflect a natural appearance.
9. In PA 3A and PA 3B, houses adjacent to Pacific Coast Highway will be separated from Pacific Coast Highway by a change in grade.
10. In PA 9, cuts and fills will be balanced on-site.
11. In PA 10A and PA 10B, the visual effect of grading will be minimized and/or mitigated by contouring as follows:
 - a. For final slopes, the angle of the graded slope shall be gradually adjusted to the angle of the natural terrain.

- b. For final slopes, sharp, angular forms shall be rounded and smoothed to blend with the natural terrain.

12. Grading shall be allowed in those portions of PA 5, PA 6, PA 12A, PA 12B, PA 12C, PA 12D, and PA 17 to the extent required to accommodate road alignments, connections, and/or improvements as provided in a Coastal Development Permit(s) for any such road project(s).

13. All grading will conform to the County of Orange Grading Ordinance.

M. DEVELOPMENT/OPEN SPACE EDGES POLICIES

The edge conditions throughout The Newport Coast vary greatly and the lines shown on the Land Use Plan show approximate development/open space boundaries which will be more precisely located with subdivision map submittals.

Along appropriate edges of PA 11A, PA 12A, PA 17, and PA 21B, one or more of the following or other treatments will be used to protect open space and habitat values from development, protect public views, and/or provide fire safety.

1. Landscape screening (including low walls, shrubs, and/or trees) and topographic screening (including berms and contour grading) will soften development edges visible from public areas.
2. In PA 3A, PA 3B and PA 14, the building setback from Pacific Coast Highway will be 100 feet for landscaping and buffering purposes.
3. In PA 6, where dwelling units are proposed on ridgelines and within 200 feet of the boundary of public recreation lands, setbacks, landscape screening, and topographic screening will be used to soften the visual impact of development as viewed from public lands.
4. Where development adjoins coastal scrub and chaparral in dense stands, an "ecotone" area will be created by thinning out woody plants in the buffer zone. Within the "ecotone" area grasses will be introduced or allowed to invade the open spaces. Such an "ecotone" will enhance and

protect wildlife and reduce fuel for fires, and will utilize either native California or non-invasive non-native plants. The establishment and maintenance of the "ecotone" area shall conform to the requirements of the County of Orange Fire Marshall.

5. Fuel modification, including selective thinning of natural vegetation, clearing and revegetation, introduction of fire resistant vegetation, installation of irrigation, may be required in order to ensure an appropriate transition from the natural area to urban development.
 - Reasonable efforts will be made in the siting of structures and selection of construction materials to minimize the need for fuel modification.
 - Where feasible and consistent with habitat management objectives, fuel modification will be located toward the development side of the edge.
 - Grading or discing for fuel modification shall not be permitted.
6. A program of fuel modification zones and/or firebreaks shall be formulated as required. The width and type of the fuel modification zone will be determined by the siting of structures, access of firefighters, density of vegetation, terrain, direction of prevailing breezes, etc.
7. Appropriate fire protection for structures in high fire-potential areas in The Newport Coast Planned Community shall be provided by using fire-resistant building materials and adequate setbacks when required on natural slopes. The County-adopted "Fire Prevention Planning Task Force Report" shall be used as the basis for fire-prevention, subject to the following standards and fuel modification descriptions:
 - a. Fire hazard potentials shall be determined for projects proposed within the hillside areas by a landscape architect. Factors such as types and moisture content of existing vegetation, prevailing winds, and topography shall be used to determine areas of fire hazard potential. Areas shall be ranked and mapped to identify fire prevention treatments and fuel modification zones. (For example, low fire hazard areas are located where existing vegetation has a year-around high moisture content and the topography is relatively flat.

Steep narrow canyons have a much higher fire hazard potential because heat and winds concentrate to drive the fire upwards much like a chimney.)

- b. A combination of techniques, including required building materials such as tile roof treatments, setback restrictions for combustible construction, irrigated buffer zones, and graduated fuel modification zones which entail selective removal of a percentage of the vegetative fuels, shall be used to lessen fire hazards. The minimum amount of native vegetation shall be selectively thinned to control the heat and intensity of wildland fires as they approach a residential area while preserving to the maximum extent feasible the quality of the natural areas surrounding the site.
- c. A Fuel Modification Plan shall be required and approved by the Director of Planning/EMA prior to obtaining any building or grading permits. The Plan shall identify appropriate setbacks and widths of fuel modification, amounts and types of vegetation to be removed and retained, and specify proposed irrigation methods to reduce the risk of fire in hillside areas. The Plan shall be approved by the Orange County Fire Department prior to submittal to the Director of Planning/EMA.
- d. Fuel Modification Plans shall be prepared as a condition of development to protect as much of the existing native vegetation as possible while providing adequate protection for residential structures from fire hazards. In no event shall thinning of more than 30% of native vegetation extend beyond 170 feet from the outward edge of residential structures (or 150 feet from the 20-foot backyard setback) in the extreme fire hazard potential areas. Fuel modification shall not occur beyond 250 feet from the 20-foot backyard setback in the extremely hazardous zones. Fuel modification in low fire hazard potential areas shall not extend more than 175 feet. Minimal irrigation during dry periods and fire represent sprinklers for native vegetation are preferred methods to reduce the width or area of fuel modification.

The intent of the Fuel Modification Plan is not to create a static 250-foot wide band surrounding development, but rather an undulating width that reflects topography and fire

hazards potential. The band shall be as narrow as possible to protect proposed structures, but in no event wider than 250 feet in extreme hazardous areas.

- e. No combustible structures including, but not limited to, houses, wood decks, sheds, gazebos, and wood fences shall be located within a 20-foot backyard setback as measured from the outward property line. Irrigation systems must be installed and operated within this setback to ensure a reasonable moisture content in planted areas.
- f. Annual maintenance shall be addressed in the Fuel Modification Plan approved as part of the Coastal Development Permit Procedure specified in LCP Chapter II-10. A public hearing shall be required to assure compliance with fuel modification standards and guarantee that the least amount and correct species of vegetation are thinned in accordance with the approved Fuel Modification Plan. Fuel Modification Plans proposing vegetation alterations within the PC (CD) District Appeals Jurisdiction may be subject to appeal review by the California Coastal Commission as provided for in the PC (CD) District Regulations.
- g. As a condition of Final Tract Map approval, project developers shall record deed restrictions that acknowledge the fire hazard potential and assign responsibility for maintenance of fuel modification zones and programs.
- h. Access roads, trails, or fire roads may be located within fuel modification areas to reduce alteration of native vegetation.
- i. The risk of fire adjacent to PA 9, the golf course, and other lower/landscape areas is substantially less than that at the tops and upper slopes of ridges. Therefore, a limit for fuel modification in this area shall be 150 feet from any habitable structure. In no event shall grading occur in the Conservation Planning Areas, and any vegetative thinning and/or replanting shall be limited to within 150 feet of the structure. Likewise, this is the maximum distance for fuel modification and flexibility for narrower widths is appropriate.

8. Where native specimen vegetation is retained within fuel modification areas, these areas shall be properly maintained to minimize fire risk.
9. Fuel breaks necessary for the protection of life and property as determined by the County Fire Marshall shall be provided for development areas. Fuel modification shall be limited to zones established adjacent to proposed development. Graduated clearing and trimming shall be utilized within these zones to provide a transition between undisturbed wildland areas and the development edge. Clearing or removal of native vegetation for fuel modification purposes shall be minimized by placement of roads, trails, and other such man-made features between the development and wildland areas. To minimize fuel modification area, other techniques (such as perimeter roads, design techniques, elimination of wood balconies and decks, fire retardant siding and tile roofs) shall be incorporated in the design and development of projects.
10. Adequate roads, water sources, and needed fire protection services shall be provided concurrent with development, located within or immediately adjacent to the developed area.

8. Where native specimen vegetation is retained within fuel modification areas, these areas shall be properly maintained to minimize fire risk.

9. Fuel breaks necessary for the protection of life and property as determined by the County Fire Marshal shall be provided for development areas. Fuel modification shall be limited to zones established adjacent to proposed development. Gravelled clearing and trimming shall be utilized within these zones to provide a transition between unmodified windward areas and the development edge. Clearing or removal of native vegetation for fuel modification purposes shall be minimized by placement of roads, trails, and other such man-made features between the development and windward areas. To minimize fuel modification areas, other techniques (such as perimeter roads, design techniques, elimination of wood balconies and decks, fire retardant siding and the roof) shall be incorporated in the design and development of projects.

10. Adequate roads, water sources, and needed fire protection services shall be provided concurrent with development, located within or immediately adjacent to the developed area.

CHAPTER 4

DEVELOPMENT POLICIES

A. TOURIST COMMERCIAL POLICIES

1. PELICAN HILL DESTINATION RESORT (PA 13A, PA 13B, PA 13C, PA 13D, PA 13E, AND PA 13F)

- a. Principal permitted use for Coastal Act purposes includes overnight/resort accommodations (such as hotel and motel rooms, casitas, resort and time-share condominiums), and uses ancillary to and directly supportive of overnight/resort accommodations, including retail commercial, service commercial, conference and meeting facilities ancillary to the accommodations, recreation and health facilities, golf courses, parking facilities in surface and/or subterranean structures, and other support facilities normally associated with resort hotels such as food preparation, housekeeping, maintenance, and manager's areas.
- b. Principal permitted uses and accessory uses, including accommodations, resort facilities, and the golf course clubhouse but excepting parking facilities and day-use commercial facilities specified in (c) below, shall be allowed up to a total of 2.66 million square feet. Within this total area, the following intensity of use criteria shall apply:
 - 1) No one of the Planning Areas PA 13A, PA 13B, PA 13C, PA 13D, PA 13E, or PA 13F shall contain more than 60,000 square feet of single, continuous primary ballroom/exhibition space. ("Single, continuous primary ballroom/exhibition space" denotes one large-scale meeting/convention area and does not include the square footage of conference facilities with smaller individual meeting rooms.)
 - 2) In these six Planning Areas, the total square footage of conference and meeting space, including primary ballroom/exhibition space and individual meeting rooms, shall not exceed 140,000 square feet.
 - 3) A total of 1,900 overnight/resort accommodations are allowed.

- 4) Within Planning Areas PA 13A-13F and PA 14, there shall be a maximum of 2,150 overnight/resort accommodation units. Of this total, (1) no more than 1,800 units may be individually owned; and (2) at least 350 units shall be hotel, motel or other non-individually owned, non-timesharing condominium resort accommodations. Coastal Development Permits for individually owned and timesharing condominium overnight/resort accommodations shall be conditioned to require contracting with a management company or companies to supply rental services to the project (e.g., advertising of units to the general public, taking reservations for the general public, housecleaning, guest check-in, security, etc.).
- 5) Casitas shall be counted as follows with respect to the maximum 1,900 permitted overnight/resort visitor accommodations:
 - a) Casitas with one or two bedrooms shall be considered one (1) overnight/resort accommodation; and
 - b) Casitas with 3 or more bedrooms shall be considered two (2) overnight/resort accommodations.
- c. Day-use retail commercial facilities, in addition to those included within hotels and other accommodations areas, are allowed, and will not exceed a total of 75,000 square feet of floor area.
- d. The architectural character of the resort area will be derived from Mediterranean hillside communities. Multi-storied structures will be varied in vertical and horizontal dimensions to reflect the hillside terrain. The building heights, setbacks, and site coverages set forth below and on Exhibit J have been designed specifically to create this Mediterranean character.

The combination of building height limits, site coverage limits, and building setbacks will create a terraced effect by placing lower structures in front of higher structures, and will break up building masses by controlling the number and location of taller structures.
- e. Maximum building heights are designated by individual height zones on Exhibit J.

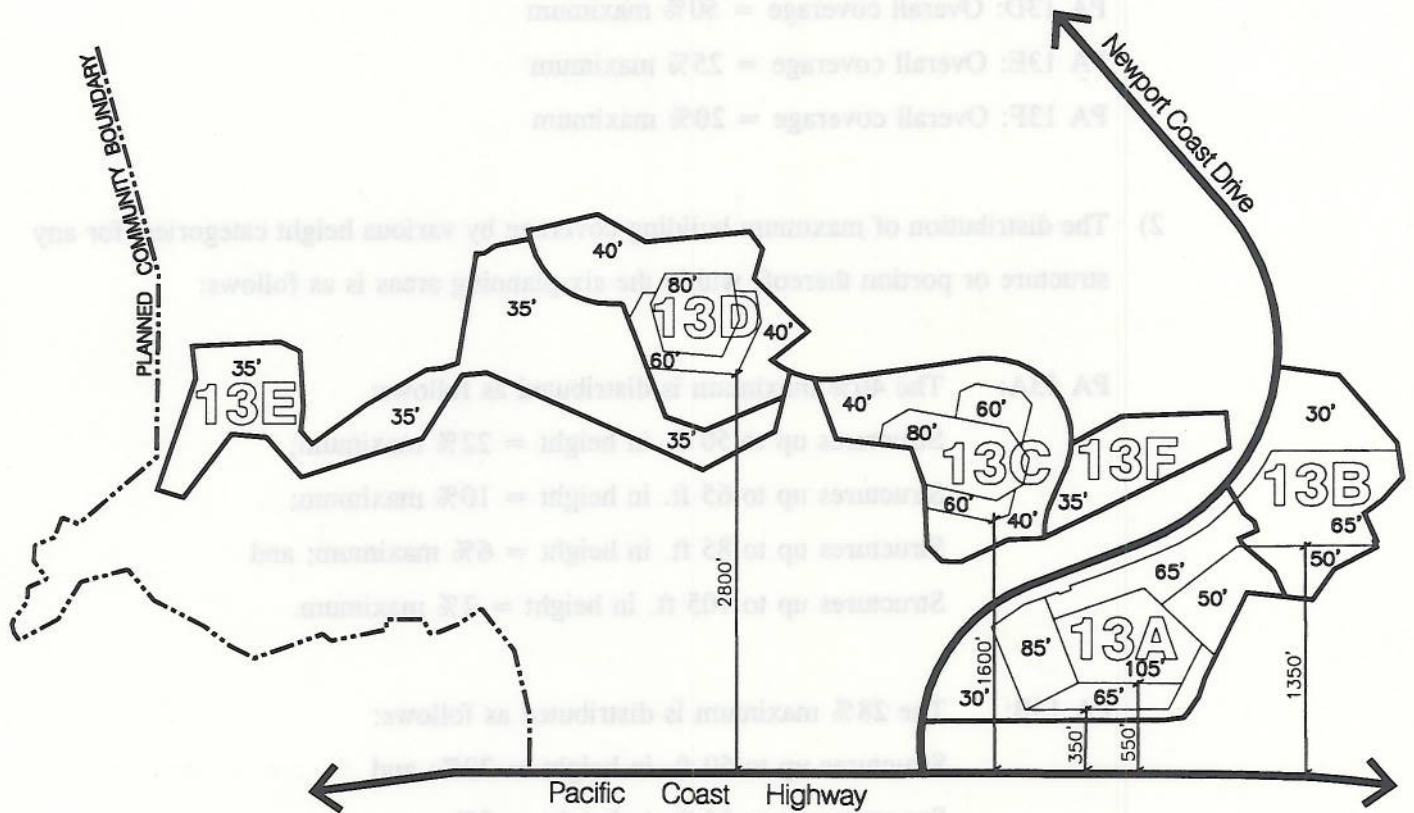

PELICAN HILL RESORT HEIGHT ZONES - Second Amendment

The Newport Coast Local Coastal Program

Exhibit J



NOT TO SCALE

December 3, 1996

f. The following maximum building coverages are expressed as a percentage of each planning area's total gross acreage:

1) The maximum building coverage (excluding parking structures) within each planning area:

PA 13A: Overall coverage = 40% maximum

PA 13B: Overall coverage = 28% maximum

PA 13C: Overall coverage = 50% maximum

PA 13D: Overall coverage = 50% maximum

PA 13E: Overall coverage = 25% maximum

PA 13F: Overall coverage = 20% maximum

2) The distribution of maximum building coverage by various height categories, for any structure or portion thereof, within the six planning areas is as follows:

PA 13A: The 40% maximum is distributed as follows:

Structures up to 50 ft. in height = 22% maximum;

Structures up to 65 ft. in height = 10% maximum;

Structures up to 85 ft. in height = 6% maximum; and

Structures up to 105 ft. in height = 2% maximum.

PA 13B: The 28% maximum is distributed as follows:

Structures up to 50 ft. in height = 20%; and

Structures up to 65 ft. in height = 8%.

PA 13C: The 50% maximum is distributed as follows:

Structures up to 40 ft. in height = 32% maximum;

Structures up to 60 ft. in height = 10% maximum; and

Structures up to 80 ft. in height = 8% maximum.

PA 13D: The 50% maximum is distributed as follows:
 Structures up to 40 ft. in height = 32% maximum;
 Structures up to 60 ft. in height = 10% maximum; and
 Structures up to 80 ft. in height = 8% maximum.

PA 13E: The 25% maximum shall all be in structures up to 35 ft. in height (i.e., no further distribution by height).

PA 13F: The 20% maximum shall all be in structures up to 35 ft. in height (i.e., no further distribution by height).

3) Minimum building setbacks from Pacific Coast Highway

PA 13A: All structures will be a minimum of 300 feet from PCH. Structures in excess of 30 feet in height and up to 85 feet in height will be a minimum of 350 feet from PCH. Structures in excess of 85 feet in height will be a minimum of 550 feet from PCH.

PA 13B: Structures in excess of 50 feet in height will be a minimum of 1,350 feet from PCH.

PA 13C/ PA 13F: Structures in excess of 40 feet in height will be a minimum of 1,600 feet from PCH.

PA 13D/ PA 13E: Structures in excess of 40 feet in height will be a minimum of 2,800 feet from PCH.

4) Terracing Criteria

a) Planning Area 13A: Consistent with Exhibit J and the overall site design ultimately required for a Coastal Development Permit application, lower structures shall be located in front of higher structures so as to present an architectural terracing effect as structures step back from Pacific Coast Highway.

- b) Planning Area 13B: Consistent with Exhibit J and the overall site design ultimately required for a Coastal Development Permit application, lower structures shall be located in front of higher structures so as to present an architectural terracing effect as structures step back from Pacific Coast Highway.

5) Landscape Screening

Landscape screening in the form of earth berms, edge planting along Pacific Coast Highway, golf course landscaping, and hotel landscaping will all combine to act as screening to soften building massing as viewed from Pacific Coast Highway.

- g. Access will be from Newport Coast Drive via a network of local roadways.
- h. Minimum landscaping for each site shall be 15% of the net area of the site.
- i. Minimum building setback from Newport Coast Drive will be 50 feet. Minimum setback for surface parking from Newport Coast Drive will be 10 feet.
- j. Grading of the Tourist Commercial sites will create a smooth and gradual transition between new and existing grades.
- k. Grading of Tourist Commercial sites may be done concurrently with grading for the golf course to balance cut and fill within the resort area and to reduce the total amount of time during which major grading operations will need to be conducted.
- l. The landscape treatment will reinforce the architectural elements of the Tourist Commercial sites within the natural and cultivated landscape of the golf course.
- m. A shuttle service for visitors will connect the visitor-serving areas with each other and with the John Wayne Airport.

2. LOWER WISHBONE (PA 14)

- a. Principal permitted use includes overnight/resort accommodations and uses ancillary to and directly supportive of overnight/resort accommodations, including rooms, retail commercial, and service commercial uses, and incidental and other support facilities normally associated with resort hotels such as food preparation, housekeeping, maintenance, and manager's areas.
- b. Incidental and accessory commercial development shall include only uses supporting and directly relating to the adjacent park, overnight/resort accommodations, and recreational visitor activities.
- c. Maximum number of overnight/resort accommodations (i.e., hotel or motel guest rooms or casitas) shall be 250. Within Planning Areas PA 13A-13F and PA 14, there shall be a maximum of 2,150 overnight/resort accommodation units. Of this total, (1) no more than 1,800 units may be individually owned; and (2) at least 350 units shall be hotel, motel or other non-individually owned, non-timesharing condominium resort accommodations. Coastal Development Permits for individually owned and timesharing condominium overnight/resort accommodations shall be conditioned to require contracting with a management company or companies to supply rental services to the project (e.g., advertising of units to the general public, taking reservations for the general public, housecleaning, guest check-in, security, etc.).
- d. Principal permitted uses and accessory uses, including overnight/resort accommodations and all directly supporting commercial facilities but excluding parking facilities and the day-use commercial described in (f) below, shall not exceed a total of 300,000 square feet. Within this total area, Planning Area PA 14 shall not contain more than 18,750 square feet of meeting space.
- e. Casitas shall be counted as follows with respect to the maximum 250 permitted overnight/resort visitor accommodations:

- 1) Casitas with one or two bedrooms shall be considered one (1) overnight/resort accommodation; and
 - 2) Casitas with three or more bedrooms shall be considered two (2) overnight/resort accommodations.
- f. Day-use retail commercial facilities, in addition to those included within hotels and other accommodations areas, are allowed and shall not exceed 25,000 square feet of floor area.
 - g. Maximum height of structures shall be 35 feet, except towers, gables, spires, flag poles, chimneys, mechanical equipment, and architectural features will have a maximum height of 47 feet.
 - h. Maximum building site coverage (excluding parking structures) shall be 50%.
 - i. Minimum site landscaping shall be 15% of the net area of the site. To minimize to the extent practicable any views of the hotel parking areas from inland portions of Crystal Cove State Park, landscape screening shall be provided parallel to the perimeter of parking areas in Planning Area PA 14 which border Muddy Canyon.
 - j. Minimum building setback from PCH is 100 feet. Surface parking is permitted in setback area.

3. LAGUNA CANYON (PA 20A)

- a. Principal permitted use includes retail commercial, service commercial, commercial recreation, and incidental and accessory uses supportive of and directly related to permitted uses and/or public works facilities.
- b. Principal permitted uses and accessory uses shall not exceed a total of 75,000 square feet of floor area.

- c. Access to the tourist commercial facilities will be directly from Laguna Canyon Road.
- d. The maximum height of facilities will be one-story and thirty-five (35) feet.
- e. Vegetation and drainage courses in Category D ESHA's will be altered or eliminated.
- f. Maximum building site coverage (excluding parking structures) shall be 45%.
- g. Minimum setbacks:
 - 1) Building from Laguna Canyon Road = 50 feet minimum; and
 - 2) Surface parking from Laguna Canyon Road = 10 feet minimum.
- h. Prior to, or concurrent with the recordation of the first final development map in PA 20A, the landowner shall record an offer to dedicate PA 16A and PA 16B. Such offer shall be subject to immediate acceptance by the County of Orange for a period of three (3) years. In the event that the County does not accept the offer during that time period, said offer shall be available for acceptance by the City of Laguna Beach for a period of three (3) years thereafter.

B. GOLF COURSE POLICIES

1. Planning Areas PA 10A and PA 10B will contain golf courses that will serve both visitors and residents. At least 50 percent of all golf course play will be reserved for visitors, including guests staying in on-site accommodations. To the extent that golf course, tennis court, and other recreational facility usage is not required to serve the recreational needs of visitors to uses located in Planning Areas PA 13A through PA 13F and PA 14, golf course, tennis court, and other play shall be made available to the public on an advance reservation basis. In order to minimize conflicts and allow efficient scheduling, a visitor play area may be separate from a resident play area.

2. Principal permitted use includes golf courses, lakes, ponds, and associated drainage facilities, driving ranges, clubhouses, tennis courts, athletic clubs, and incidental and accessory commercial and non-commercial recreation facilities. Except for the golf course play area, driving range, and putting greens, all golf course related uses shall be included within the total square footage allowed for PA 13 uses.
3. Collector roads to serve visitor accommodations and other land uses will be located in PA 10A.
4. Golf courses will be subject to a permanent open space easement upon completion.
5. As part of the review and approval of a coastal development permit for the golf course in PA 10A and PA 10B, a "Riparian Habitat Creation Program" (RHCP) will be submitted in accordance with the following criteria and the standards set forth in LCP Subsection II-6-E-8¹:
 - a. Drainage profiles will be re-constituted and new riparian habitat will be established in selected drainage courses in PA 10A and/or PA 11B totaling approximately 4,000 lineal feet and utilizing one or more of the following enhancement concepts (see Pelican Hill Drainage Habitats, Larry Seeman Associates, September 1986, provided in the Appendix to this LCP, for further definition of enhancement concepts):
 - 1) Sycamore planting;
 - 2) Willow planting;
 - 3) Willow/mulefat establishment;
 - 4) Elderberry riparian establishment;
 - 5) Grade control;
 - 6) Pocket riparian establishment;
 - 7) Arroyo enhancement/establishment; and
 - 8) Pond establishment.

¹ RHCP finalized in January 1990 and installed with construction of the golf courses.

- b. The Riparian Habitat Creation Program will ensure that runoff from the golf course and the water features of the golf courses will be used as sources of year-round water supply for the support of riparian vegetation enhancement in drainage courses identified in PA 10A and PA 11B, and that any water supply required to supplement these sources for nourishment of riparian vegetation shall be provided.
- c. The Riparian Habitat Creation Program will specify an implementation schedule phased with the construction of the golf course.
- d. The Riparian Habitat Creation Program will specify a minimum width of 15 feet on both sides of the drainage course. Therefore, the minimum width of the drainage course will be 30 feet.
- e. The riparian drainage course shall include an understory similar to that found in Buck Gully and Los Trancos Canyon. Existing non-native plants shall be carefully removed only as necessary to retain the integrity of the riparian corridor.
- f. Water quality in the riparian drainage course shall be monitored. The monitoring program shall be submitted prior to coastal development permit approval for the golf course.

C. RECREATION/PUBLIC ACCESS POLICIES

Land use policies concerning recreation and public access are applicable to specified planning areas only.

Planning Area PA 17 contains 2,807 Crystal Cove State Park. A Public Works Plan has already been certified by the Coastal Commission for this planning area obviating the need to include separate policies in this LUP.

Planning Areas PA 18, PA 19, PA 21A, PA 21B, PA 21C, and PA 21D accommodate the County's Irvine Coast Wilderness Regional Park as described in LUP Chapter 3. Recreation Planning Areas PA 11A, PA 11B, PA 12A, PA 12B, PA 12C, PA 12D, PA 12E, PA 12H and PA 12I adjoin

residential land use areas and preserve archaeological/paleontological sites and identified ESHA's in Buck Gully, Los Trancos/Muddy Canyons, and the frontal slopes of Pelican Hill and Lower Wishbone. Planning Area 12F contains the existing El Morro Elementary School and PA 12J contains existing Laguna Beach County Water District facilities. Policies for these Planning Areas are also described in LUP Chapter 3.

Recreation Planning Areas PA 16A, PA 16B, PA 20B, and PA 20C are adjacent to Laguna Canyon Road:

1. LAGUNA CANYON (PA 16A, PA 16B AND PA 20B¹)

- a. Principal permitted use includes parking facilities, educational and cultural facilities, recreation support facilities, flood control and drainage facilities, and public utilities. USGS Drainage Courses will be filled in these sites. These three small parcels are adjacent to Laguna Canyon Road.
- b. Access will be provided directly from Laguna Canyon Road.

2. PLANNING AREAS PA 12G AND PA 20C:

- a. Principal permitted use includes commercial recreation related to park use, specialty retail shops related to park use, restaurants and food sales serving visitors to the adjacent Regional and State Parks, educational and cultural facilities, gardens, staging areas and Regional Park support facilities.
- b. Principal permitted uses (excluding gardens) shall not exceed a total of 7,500 square feet of floor area directly related to and/or supportive of the 1) nearby parks and 2) recreational visitor activities.

¹ The principal permitted uses in Planning Area 20B are subject to a deed restriction limited to open space under the provisions of an agreement with the County of Orange.

c. The maximum height of facilities will be one-story and fifteen (15) feet for PA 12G and twenty-five (25) feet for PA 20C.

d. Maximum building site coverage shall be 12%.

D. RESIDENTIAL POLICIES

1. GENERAL RESIDENTIAL

a. All of the residential categories are described in terms of character, dwelling units, and density per gross residential acre.

b. Residential categories may include public and private facilities compatible with the residential uses, such as schools, libraries, post offices, museums, art galleries, parks, recreation facilities, and neighborhood commercial uses.

c. Neighborhood commercial facilities within specified residential planning areas will be permitted up to a maximum of 10 gross acres with a maximum building floor area of 100,000 square feet.

d. Prior to, or concurrent with, the recordation of final subdivision maps, designated open space areas within the subdivision will be subject to easements, dedications, CC&R's, or other mechanisms to ensure permanent open space use.

2. PELICAN POINT (PA 9)

a. Primary structures within Pelican Point will be designed and supported so that the stability of such structures will not be affected by bluff erosion, assuming no shoreline protection, for a minimum of 50 years. Setbacks, deep foundation support, and/or other methods may be used subject to a geologic report and County approval.

- b. Oceanfront setbacks will be subject to an open space easement as a condition of development approval.
- c. Grading, as it may be required to establish proper drainage, install landscaping, construct trails and related improvements, protect adjacent development, repair bluff slopes, and improve bluff stability, may be permitted within the setback.
- d. Pelican Point will provide for a bluff top trail connecting Crystal Cove State Park, where topographic and geologic conditions permit¹.
- e. A smooth and gradual transition between graded and existing slopes will be maintained.
- f. The golf course in PA 10A and PA 10B north of Pacific Coast Highway may be extended into PA 9 subject to the Golf Course Policies contained in the preceding LUP Section I-4-B. Golf course usage may include related clubhouse and/or incidental and accessory golf course uses which shall be limited to a maximum of 10,000 square feet. Such golf course-related uses shall be included within the total square footage allowed for PA 13 uses, as provided for in Subsection A-1-b of this Chapter. If the golf course is extended into PA 9, the clustering of residential development shall concurrently be permitted in PA 9. Clustered residential use may include residential planned developments, condominiums, and stock cooperatives, subject to the Residential Policies conformed in this Section, and a maximum building height of twenty-eight (28) feet.

3. WISHBONE RIDGE (PA 6)

- a. In order to protect the visual and habitat resources of Wishbone Ridge, residential development will be limited to a maximum of 75 single-family dwelling units and shall require a public hearing before the Planning Commission.
- b. Lot size will be a minimum average of 30,000 square feet.

¹ The bluff top trail has been constructed.

- c. Access will be from a network of local roadways.
- d. Any necessary buffer or transition zones between PA 6 and PA 17 (i.e., Crystal Cove State Park) will be located within PA 17 in accordance with established easements.
- e. In order to maximize visual protection for public lands in the Wishbone Ridge area of Crystal Cove State Park, the subdivision of PA 6 shall assure that individual lots can be developed for single family homes in such a way as to maintain the existing undeveloped visual qualities (i.e., the visual character of the indigenous plant community) as viewed from the potential Moro Canyon Trail shown on Exhibit K. All lots within PA 6 shall be configured in such a way as to allow the future homeowner the ability to meet the aforementioned policy standard. In addition to applying this review standard at the subdivision stage, each permit application for development on these lots shall demonstrate how the individual lot development (structures and fencing) maintains the existing undeveloped visual qualities as viewed from the potential Moro Canyon Trail shown on Exhibit K.

At the time of subdivision, all lots in PA 6 shall incorporate a building envelope which indicates the maximum building heights combined with necessary setbacks allowable on each parcel. The building envelope shall define the necessary combination of heights and setbacks applicable to each lot required to meet these policy standards and shall be reflected in the CDP and CC&R's for the subdivision.

Development shall be sited so as to not be visible to persons located on the Moro Canyon Trail (or, if the Trail is not constructed at the time of subdivision, the proposed Trail located shown on Exhibit K). In a few cases this may be difficult to achieve, therefore, in these areas minor amounts of berming, landscaping, and the blending of exterior colors with indigenous plants and soils may be used to achieve the objective of this policy (i.e., maintain the existing undeveloped quality). The blending of slopes and use of variable slopes will be employed where reasonable to restore the natural appearance to the transition between the open space and graded areas. Night lighting shall be directed away from Crystal Cove State Park.

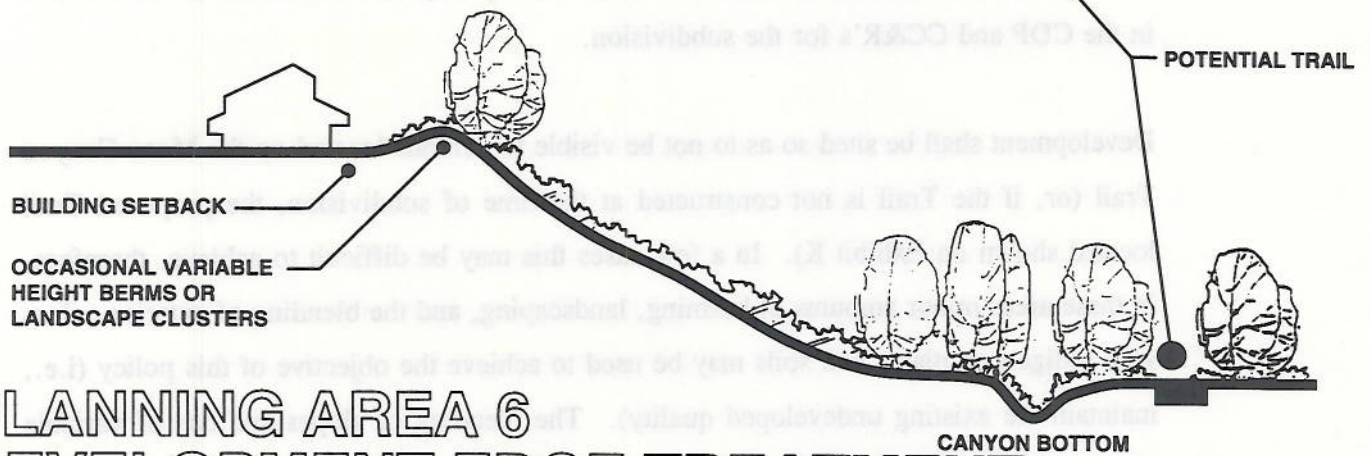
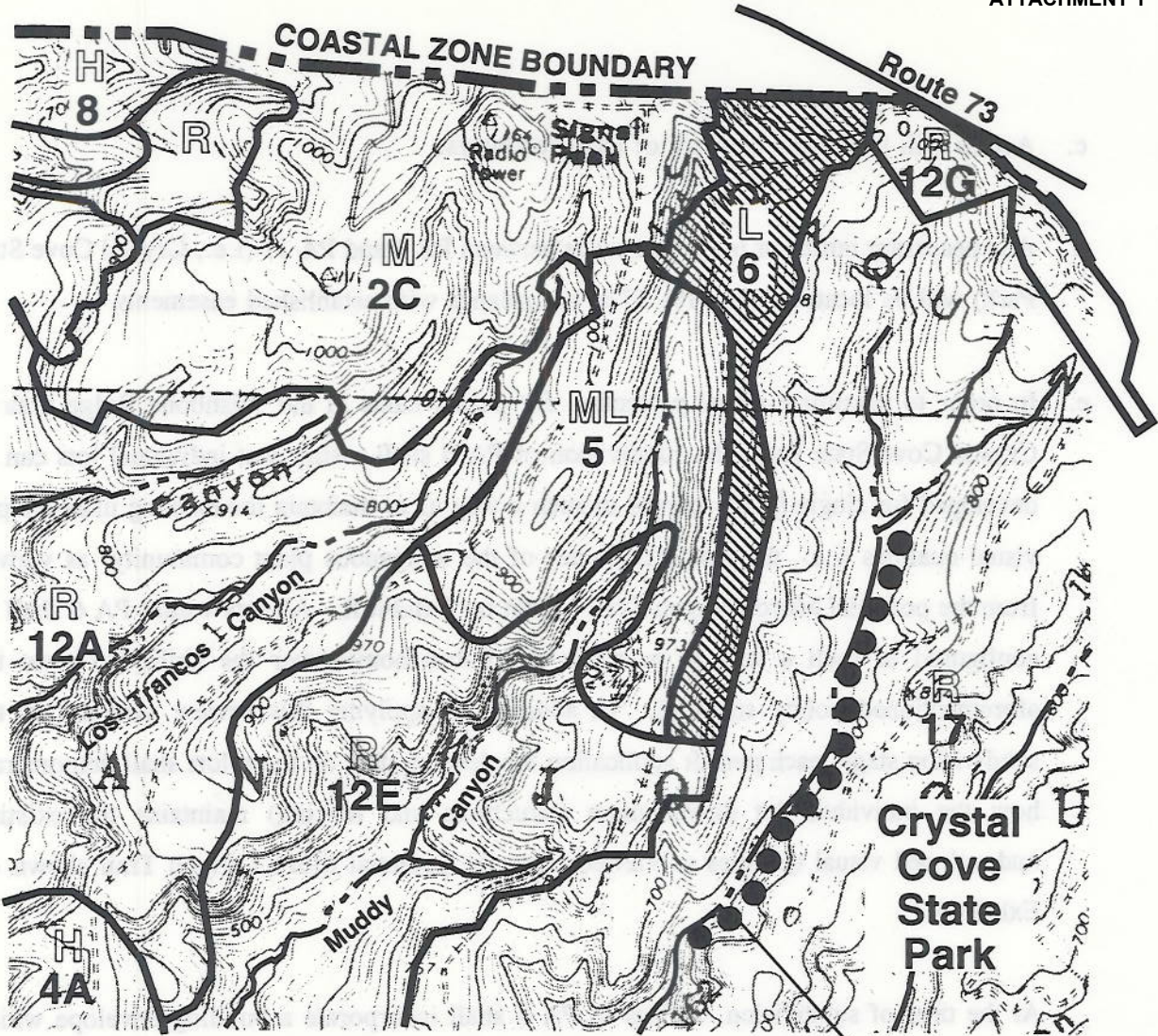

PLANNING AREA 6 DEVELOPMENT EDGE TREATMENT - Second Amendment

The Newport Coast Local Coastal Program

Exhibit

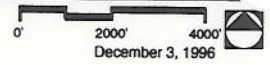

E. TRANSPORTATION/CIRCULATION POLICIES

The Transportation Element of the County General Plan has as its primary goal to:

"Develop an integrated transportation system consisting of a blend of transportation modes capable of meeting the continuous need to move people and goods by private and public means with maximum efficiency, convenience, economy, safety, and comfort; and a system that is consistent with other goals and values of the County and the region."

A primary purpose of this Element is to provide an Arterial Highway System providing maximum efficiency, convenience, and safety, which is implemented in a manner that requires the provision of those roadways to keep pace with development.

A key policy for arterial highway development is to assign a high priority for roadway improvement/construction that would complete essential gaps in the Master Plan of Arterial Highways. The goals, purposes, and the policies of the Transportation Element of the General Plan have been reflected in this LCP.

Capacity deficiencies already exist on Pacific Coast Highway and other roadways in the area surrounding the project. These deficiencies will increase to varying degrees with or without the project. However, the service levels will deteriorate to a greater degree without the project than with the project. With project implementation, there will be a substantial net increase in traffic capacity and a significant incremental improvement in level of service on both roadway links and intersections in this area. Without implementation of the project, regional commuting traffic is not offered alternate routes around capacity-deficient areas, and levels of service in these areas will continue to deteriorate from traffic related to regional traffic growth.

Thus, the spirit and intent of the Transportation Element's policies to improve the level of service and operational characteristics in the area are met with this project.

The Newport Coast LCP requires a significant commitment of financial resources early in the project to achieve these goals. In recognition of this financial burden to the landowner and the need to complete the project to amortize that investment, and of the importance of these traffic improvements

to the County, it is the intent of the County and the landowner to enter into a development agreement or other mechanism.

The policies that follow identify the specific assurances that the goals of the Transportation Element of the General Plan will be implemented:

1. ROADWAY IMPROVEMENTS

Newport Coast Drive is designated as a 6-lane major arterial. Pacific Coast Highway is designated as a 6-lane major arterial highway from immediately north of Newport Coast Drive to the southern boundary of PA 14; and a 4-lane primary arterial highway from Newport Coast Drive to the City of Newport Beach, and south of PA 14 at the City of Laguna Beach. The alignment for Newport Coast Drive is shown on the Land Use Plan (Exhibit F) and Exhibit L. The alignment for Pacific Coast Highway remains in its current location within the Plan, as shown on Exhibit F. Adjacent to The Newport Coast Project, Pacific Coast Highway will be widened to its master planned width in conjunction with adjacent Newport Coast development areas. Widening adjacent to State Park facilities is to be completed by others. Typical sections for these roadways are shown on Exhibits M and N.

2. ROADWAY PHASING

The construction of Newport Coast Drive, and Pacific Coast Highway widening improvements shall be implemented in a manner which is consistent with policies adopted in the 1981 Irvine Coast LCP. Newport Coast Drive shall be phased such that four travel lanes from Pacific Coast Highway to MacArthur Boulevard shall be completed prior to issuance of the certificate of occupancy for development inland of Pacific Coast Highway which generates in excess of 4,560 Average Daily Trips (based upon daily trip generation from 100 low density residential units, 350 hotel rooms and 25,000 square feet of directly-related support commercial facilities approved in the previous LCP). Additional lanes of Newport Coast Drive within the project boundaries up to the maximum size of 6-lanes, shall be constructed at the time that Newport Coast development adjacent to Newport Coast Drive requires additional road capacity beyond the initial 4-lanes to serve traffic generated by such development. Similarly, Pacific Coast

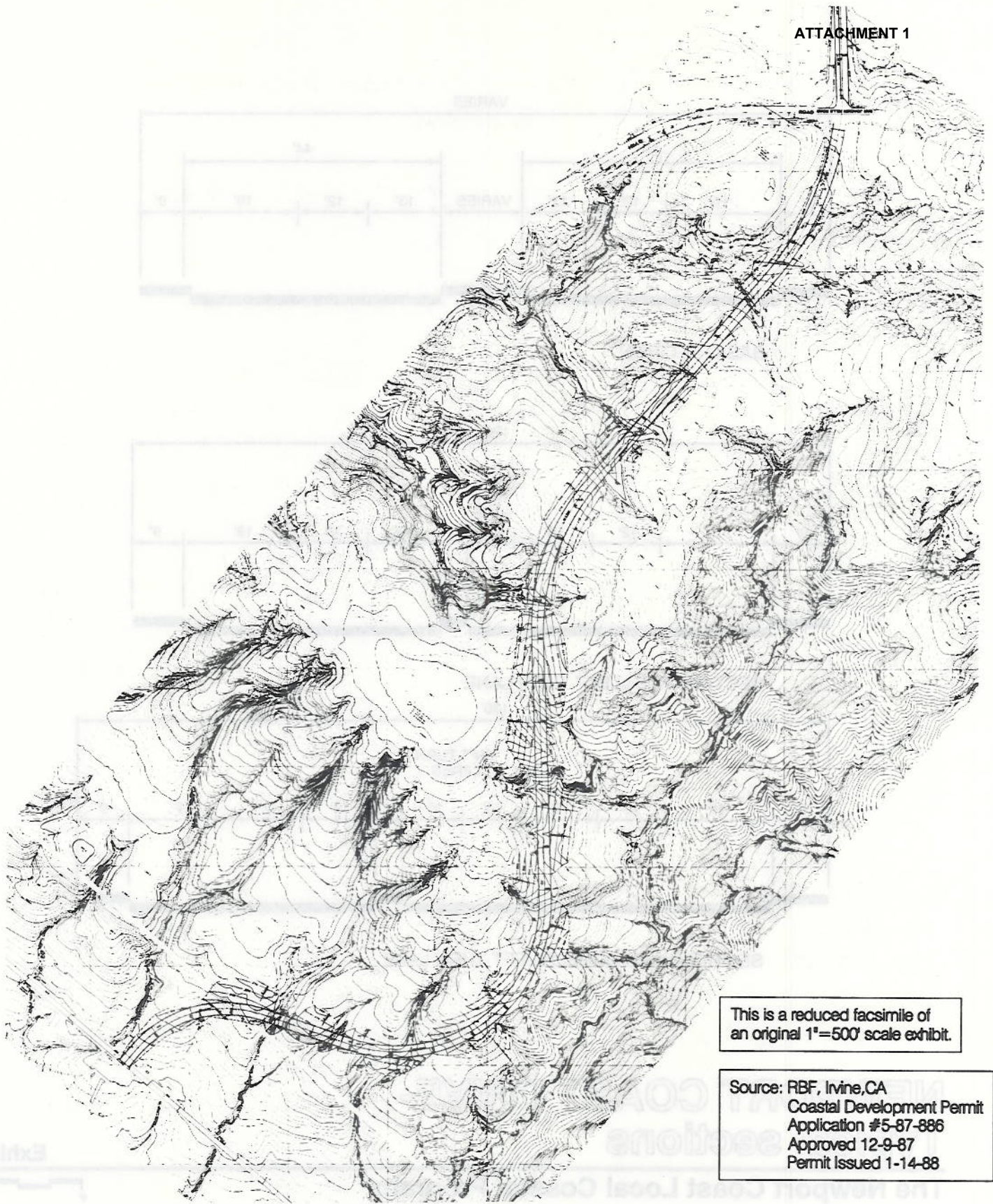

This is a reduced facsimile of an original 1"=500' scale exhibit.

Source: RBF, Irvine, CA
Coastal Development Permit
Application #5-87-886
Approved 12-9-87
Permit Issued 1-14-88

NEWPORT COAST DRIVE ALIGNMENT

The Newport Coast Local Coastal Program

Exhibit L

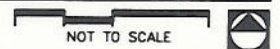

December 3, 1996

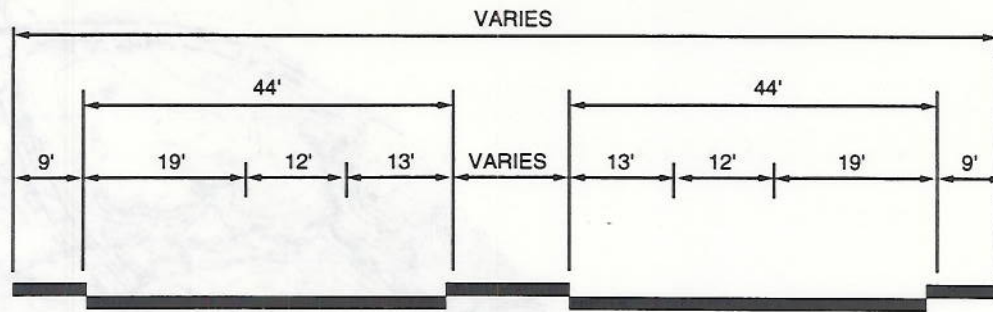

BASIC SECTION

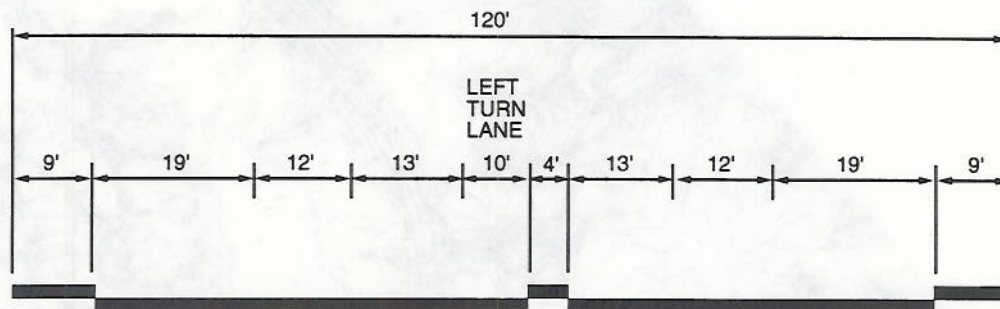

SECTION WITH LEFT TURN LANE

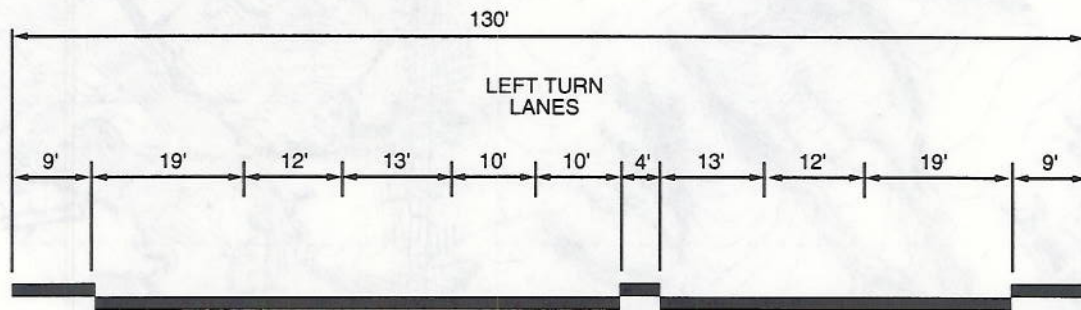

SECTION WITH DOUBLE LEFT TURN LANE

NEWPORT COAST DRIVE- Typical sections

The Newport Coast Local Coastal Program

Exhibit M



December 3, 1996

NEWPORT COAST DRIVE ALIGNMENT
The Newport Coast Local Coastal Program

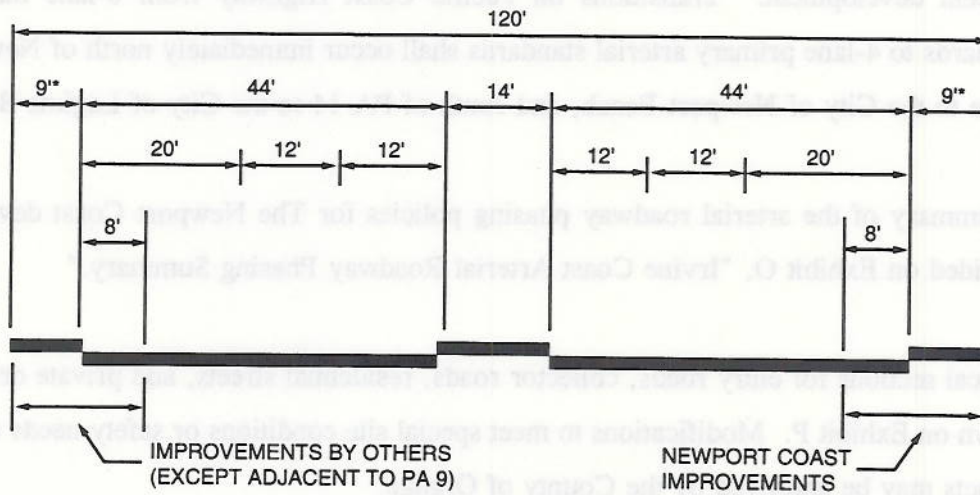

BASIC SECTION

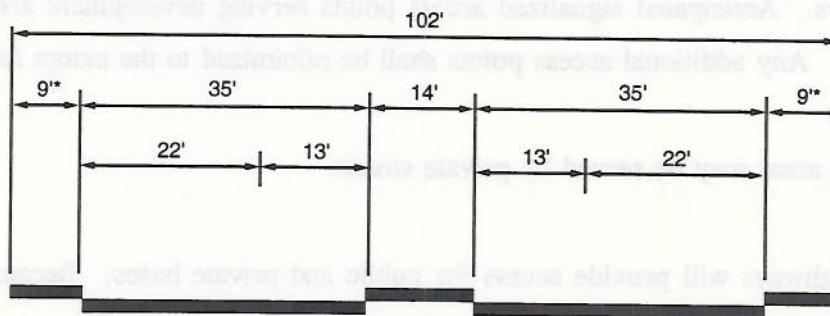

TRANSITION / EXISTING SECTION

*UNPAVED PARKWAY

PACIFIC COAST HIGHWAY Typical Sections

The Newport Coast Local Coastal Program

Exhibit N

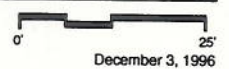

Highway will be widened consistent with 6-lane major arterial standards in conjunction with adjacent development. Transitions on Pacific Coast Highway from 6-lane major arterial standards to 4-lane primary arterial standards shall occur immediately north of Newport Coast Drive to the City of Newport Beach, and south of PA 14 to the City of Laguna Beach.

A summary of the arterial roadway phasing policies for The Newport Coast development is provided on Exhibit O, "Irvine Coast Arterial Roadway Phasing Summary."

3. Typical sections for entry roads, collector roads, residential streets, and private driveways are shown on Exhibit P. Modifications to meet special site conditions or safety needs or to reduce impacts may be approved by the County of Orange.
4. Access to arterial highways from development will occur by means of primary, secondary, and emergency access points.
5. Access points on Pacific Coast Highway will be located in a manner to ensure safe and efficient traffic flows. Anticipated signalized access points serving development areas are shown on Exhibit W. Any additional access points shall be minimized to the extent feasible.
6. Residential areas may be served by private streets.
7. Arterial highways will provide access for public and private buses. Because of topographic constraints, no exclusive bus or HOV lanes are to be provided.
8. Commercial areas and/or the State Park will provide parking space for private (charter) buses and transit stops for public buses where feasible.
9. A regional Class II (on-road) bike trail will be located along Pacific Coast Highway and Newport Coast Drive¹.

¹ Class II bike trails completed with the widening of Pacific Coast Highway and the construction of full improvements for Newport Coast Drive.

EXHIBIT O

NEWPORT COAST ARTERIAL ROADWAY PHASING SUMMARY
Newport Coast Local Coastal Program

ROADWAY IMPROVEMENT	TRIGGERING MECHANISM
2 lanes of San Joaquin Hills Road-existing terminus to Newport Coast Drive. ¹	Pelican Hill/Pelican Ridge Development generating up to 4,560 ADT* (PA1A, PA1B, PA1C, PA2A, PA2B, PA2C).
4 lanes of Newport Coast Drive — from San Joaquin Hills Road to Development Area access. ¹	
4 lanes of Newport Coast Drive — Pacific Coast Highway to MacArthur Boulevard. ¹	Occupancy of development inland of Pacific Coast Highway generating in excess of 4,560 ADT.*
2 additional lanes on Newport Coast Drive (6) total between Pacific Coast Highway and San Joaquin Hills Road. ¹	Adjacent Pelican Hill Frontal Slope Occupancy (PA13A, PA13B).
1 additional southbound lane on Pacific Coast Highway — PA9 Frontage. ¹	Adjacent Pelican Point Occupancy (PA9).**
1 additional northbound lane on Pacific Coast Highway from Sand Canyon Entry to Newport Coast Drive. ¹	Adjacent Pelican Hill Frontal Slope Occupancy (PA13A, PA13B).
1 additional northbound lane on Pacific Coast Highway between: <ol style="list-style-type: none"> 1) Crystal Cove State Park and Sand Canyon Entry;¹ and 2) Newport Coast Drive and Corona Del Mar.¹ 	Adjacent Pelican Hill Ridge/Pelican Hill Frontal Slope Development and adjacent Muddy Canyon Occupancy (PA13C, PA13D, PA14).

* Initial development inland of Pacific Coast Highway shall be limited to a 4,560 ADT total trip ceiling prior to the implementation Newport Coast Drive to MacArthur Boulevard, which equates to development allowed inland of Pacific Coast Highway in the 1981 LUP approval. Said initial development inland of Pacific Coast Highway shall be allowed in Planning Areas PA1A, PA1B, PA1C, PA2A, PA2B, PA2C, PA3A, and PA3B, as long as the total cumulative trip generation does not exceed the 4,560 ADT ceiling.

** Implementation of Planning Areas PA3A, PA3B, and PA9 is not only subject to the applicable restrictions discussed in the previous footnote but is further limited to allow issuance of building permits in those areas only when the grading of Newport Coast Drive has started. Further, the amount of development, on a cumulative basis, for Planning Areas PA4A, PA4B, and PA9 is to be limited so that the 101st occupancy permit cannot be issued prior to the opening of Newport Coast Drive through to MacArthur Boulevard.

¹ Roadway improvements have been completed.

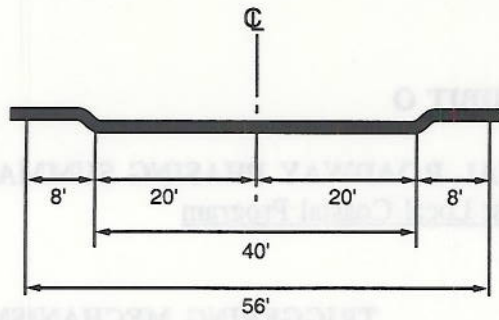

ENTRY ROAD

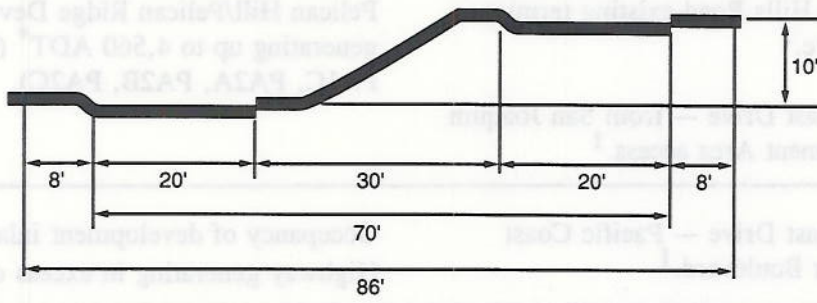

ENTRY ROAD

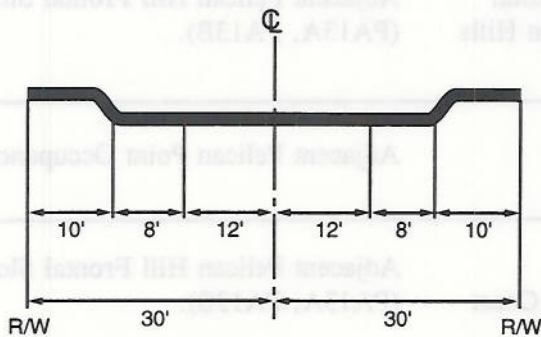

COLLECTOR ROAD

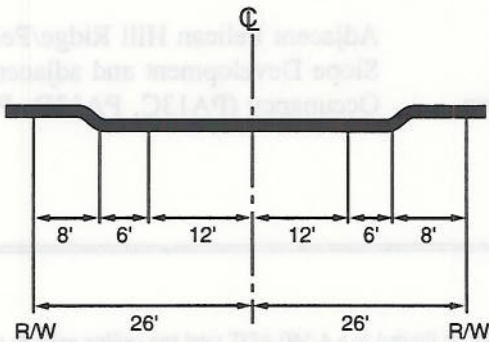

RESIDENTIAL STREET <500 ADT

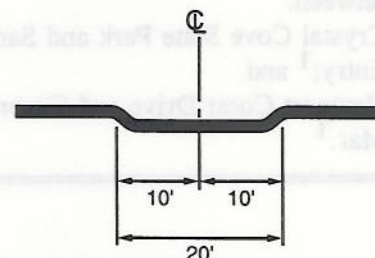

PRIVATE DRIVES

RESIDENTIAL ENTRY ROAD & RESIDENTIAL STREETS- Typical Sections

The Newport Coast Local Coastal Program

Exhibit P

10. Roadway design will generally reflect a rural rather than urban character. Where feasible, precise roadway alignments shall preserve the natural topography and avoid environmentally sensitive areas.
11. Modifications to existing roadway standards will be carefully considered where justified by safety and circulation conditions.
12. Where appropriate, sidewalks will not be required in Low Density and Medium-Low Density residential areas that abut open space areas.
13. Public vistas to the ocean will be afforded along Newport Coast Drive where feasible¹.
14. Roadway grading shall be blended into existing topography by contour grading, where feasible. Retaining walls and other structures may be used to minimize grading impacts.
15. Visibility of terrace drains will be minimized to the greatest extent feasible through landscaping.
16. Any landscaping on public roads will make a gradual transition to native vegetation where applicable.
17. Improvements to accommodate widening of Pacific Coast Highway shall be allowed, and constitute a principal permitted use in PA 3A, PA 3B, PA 9, PA 10A, PA 10B, PA 14, and PA 17.
18. In 1979, the County certified final EIR 267 for the San Joaquin Hills Transportation Corridor (State Route 73) and selected a locally-preferred route which would involve grading and construction in a small portion of the most inland area of coastal zone. This alignment will be under further review in a joint EIR/EIS currently being prepared with CalTrans as the lead agency for CEQA purposes and the FHWA as the lead agency for NEPA purposes. The following policy provides for the grading area identified pursuant to EIR 267:

¹ Completed with approval of CDP (CD 91-007P), that permits three view parks along Newport Coast Drive.

a. **San Joaquin Hills Transportation Corridor:**

Improvements in the grading area identified in Orange County EIR 267 required to accommodate grading and construction for the San Joaquin Hills Transportation Corridor (SJHTC, SR 73) may be located in PA 2C and PA 6 when found consistent with the LCP in a Coastal Development Permit for the SJHTC, SR 73.

19. The policies below provide for grading and construction required for the following project:

a. **Laguna Canyon Road:**

Improvements to accommodate the widening and/or relocation of Laguna Canyon Road shall be allowed in PA 16A, PA 16B, PA 20A, PA 20B, PA 20C, PA 21A, and PA 21B, provided that any such project is the least environmentally damaging feasible alternative, as determined and approved by the California Coastal Commission.

20. Traffic management program measures, including but not limited to the following, shall be encouraged by the landowner, operators, and lessees as appropriate at all stages of project development and buildout. Each Coastal Development Permit within an individual planning area shall be accompanied by a description of specific traffic management program measures, as appropriate, which shall be carried out in furtherance of this policy:

- a. Vanpool and carpool programs which encourage and assist people in forming rideshare groups;
- b. Setting aside preferred parking for people who share rides;
- c. Operating shuttles to transit stops, airports, and selected points of visitor attraction from overnight/resort accommodations. The use of shuttles should be correlated with the buildout of visitor areas and real demand for shuttle services. Additionally, project hotels shall make cars available for guest use in accordance with guest needs and accepted hotel management practices;

- d. Setting up "transportation stores" to disseminate information on bus schedules and ridesharing;
 - e. Construction of pedestrian and bicycle paths connecting areas of interest, in accordance with County management policies and golf course/resort management needs;
 - f. Establishing efficient signal timing to speed traffic flows;
 - g. Within the policies of the appropriate transit provider, encourage increased frequency and range of public transit, and;
 - h. Providing bus-related transit facilities, where appropriate, such as bus shelters, bus pullouts, and bus turnarounds.
21. Recognizing that Pacific Coast Highway is subject to complex regional impacts, the Growth Management Program is defined in IAP General Provision Subsection II-3-A-9. Therefore the AMR procedure in relationship to this project's traffic impacts focuses only on the link traffic volumes of Newport Coast Drive within the Coastal Area. For each year that the Orange County Annual Monitoring Report indicates that segments of Newport Coast Drive located within The Newport Coast Planned Community are shown to be operating at traffic conditions worse than Level of Service "C" during commuter A.M./P.M. peak hours (i.e., an .80 v/c ratio or greater for an average peak hour weekday condition), the landowner shall prepare and submit a report to the County EMA to be approved by the Planning Commission containing the following information:
- a. An analysis that determines the source of the trips on the roadway link(s) in question by quantifying: 1) the number of trips which are directly attributable to development located within Planning Areas PA 1 through PA 10, PA 13, PA 14, PA 16 and PA 20; and 2) the remaining number of trips which are regional, through traffic, or traffic generated from other sources; and

- b. If the analysis determines that the amount of trips generated by the above-referenced Newport Coast Planning Areas is 10% or more in excess of the trip generation projections estimated for equivalent levels of development in the "Irvine Coastal Areas Traffic Analysis" (Austin-Foust Associates, Inc., February 1987) then the report shall include an analysis of the traffic mitigation measure currently being implemented and recommend additional feasible mitigation measures which would be implemented within the LCP development area to further reduce project generated trips.

The highway improvements and phasing as defined in this Section E and on Exhibit O, which are required by this LCP, have been determined to be of significant public benefit beyond normal project requirements so as to meet the objectives of the County's Growth Management Policy. Consistent with this LCP, highway improvements and implementation of the Growth Management Program identified above will be incorporated into subsequent agreements, if any, between the landowner and County.

22. To the maximum extent feasible, heavy construction traffic (i.e., dirt moving equipment, dump trucks, and cement trucks) will access the Newport Coastal properties of Pelican Hill from Newport Coast Drive. Construction traffic for Pelican Point, Wishbone, and Pacific Coast Highway widening requiring access from Pacific Coast Highway will be restricted on Pacific Coast Highway to periods of non-peak traffic. The applicant shall provide on-site parking for construction vehicles working adjacent to the Pacific Coast Highway as soon as possible to minimize impacts on PCH.

F. PUBLIC WORKS/INFRASTRUCTURE POLICIES

1. All public works/infrastructure collection, distribution, and drainage facilities within residential and commercial areas necessary to support designated land uses from these systems are principal permitted uses under this Land Use Plan.

2. Exhibits Q, R and S illustrate the concept plans for backbone water service, sewer service, and drainage facilities, respectively. These concept plans were prepared with the most current information available but are subject to refinement at more detailed stages of planning. Necessary above-ground public works, infrastructure, and utility facilities will be located and designed to minimize visual impacts.
3. All necessary water service improvements, including pipelines, booster stations, and other facilities will be designed in conjunction with the final tract maps.
4. The water system will be designed to provide adequate fire flows. Water reservoirs may be located above ground.
5. Two water storage and transmission facilities will be located in Conservation areas to serve fire and domestic needs of adjoining development, both existing and proposed. One is currently located on the lower portion of one of the ridges in PA 17. The other will be located on the lower portion of the ridge in PA 21.
6. All necessary sewer service improvements, including pipelines, pump stations, and other facilities will be designed in conjunction with final tract maps.
7. All necessary drainage improvements, including storm drains, detention basins within drainage courses, and other facilities will be designed in conjunction with final tract maps.

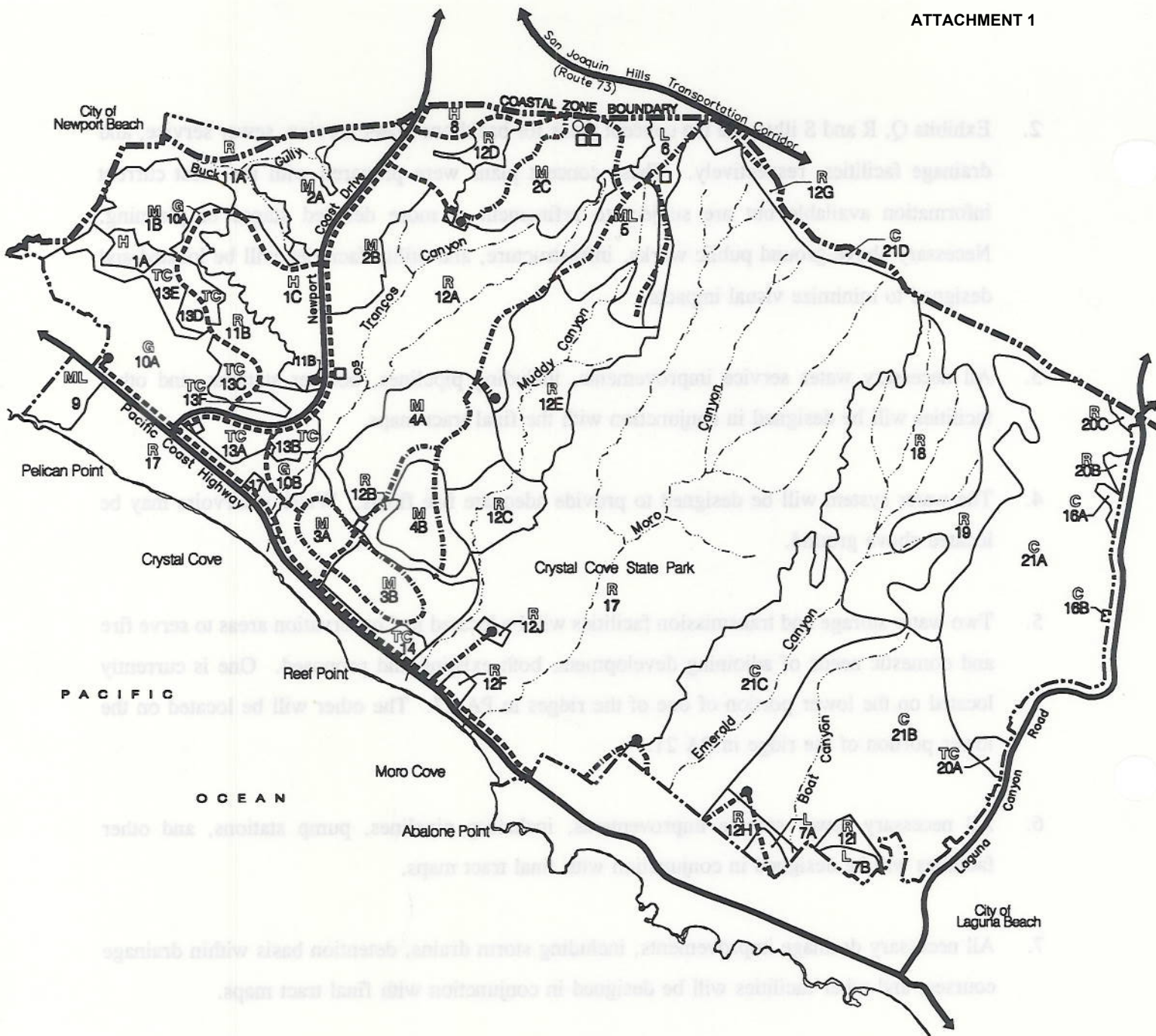

BACKBONE WATER CONCEPT - Second Amendment

Exhibit Q

The Newport Coast Local Coastal Program

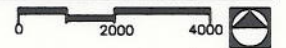

December 3, 1996

LEGEND

- | | |
|---------------------------|----------------------------|
| RECLAIMED WATER RESERVOIR | COASTAL ZONE BOUNDARY |
| WATER RESERVOIR | PLANNED COMMUNITY BOUNDARY |
| PUMP STATION | PLANNING AREA BOUNDARY |
| EXISTING PIPELINE | 21A PLANNING AREA |
| WATER MAIN | |

This is a graphic representation of a planning/engineering concept. Final design solutions and precise locations for these facilities will be proposed and reviewed as part of subsequent plan approvals.

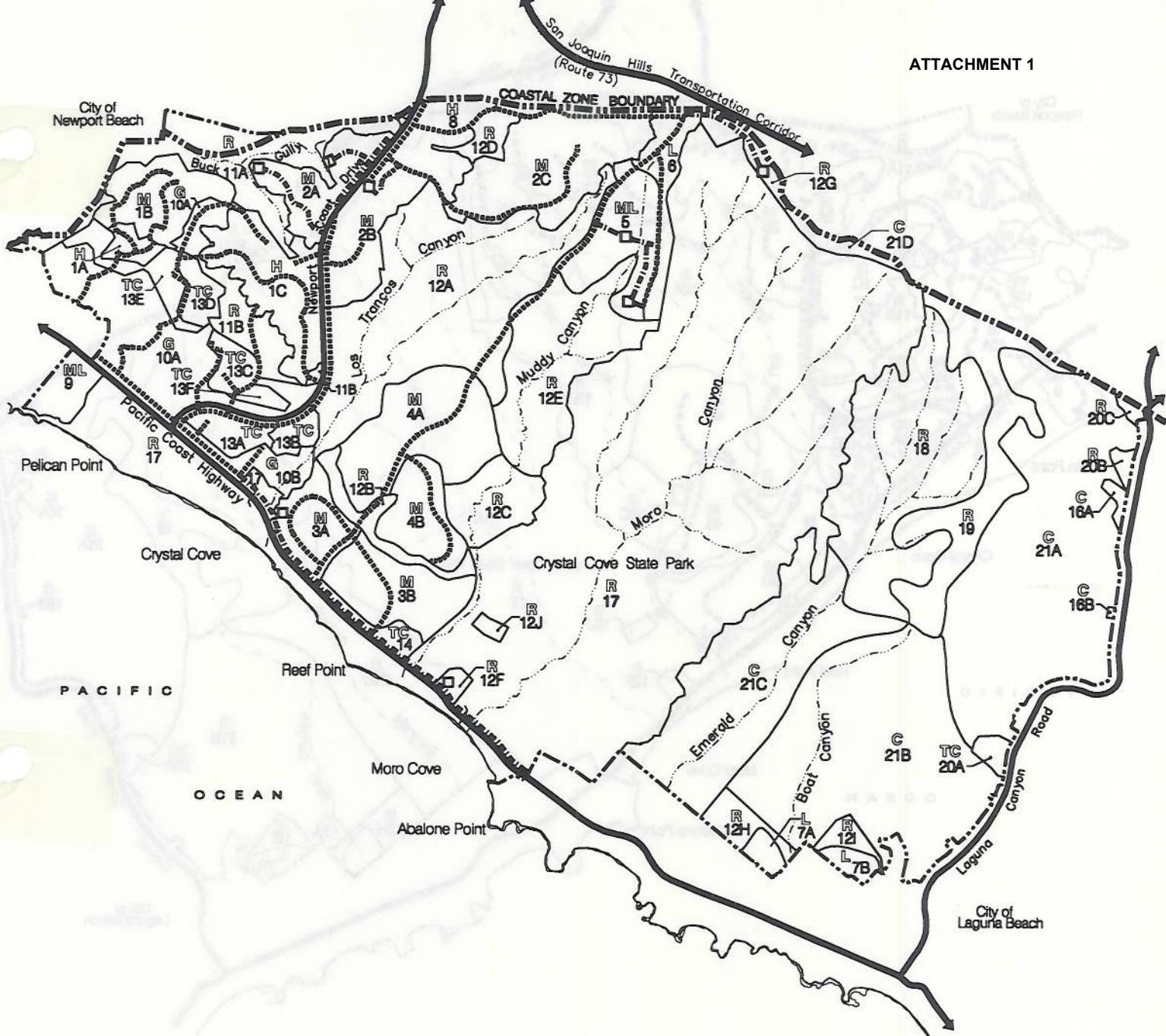

BACKBONE SEWER CONCEPT - Second Amendment

The Newport Coast Local Coastal Program

Exhibit R

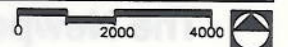

December 3, 1998

LEGEND

- LIFT STATION
- SEWER
- FORCE MAIN
- COASTAL ZONE BOUNDARY
- PLANNED COMMUNITY BOUNDARY
- PLANNING AREA BOUNDARY
- 21A PLANNING AREA

This is a graphic representation of a planning/engineering concept. Final design solutions and precise locations for these facilities will be proposed and reviewed as part of subsequent plan approvals.

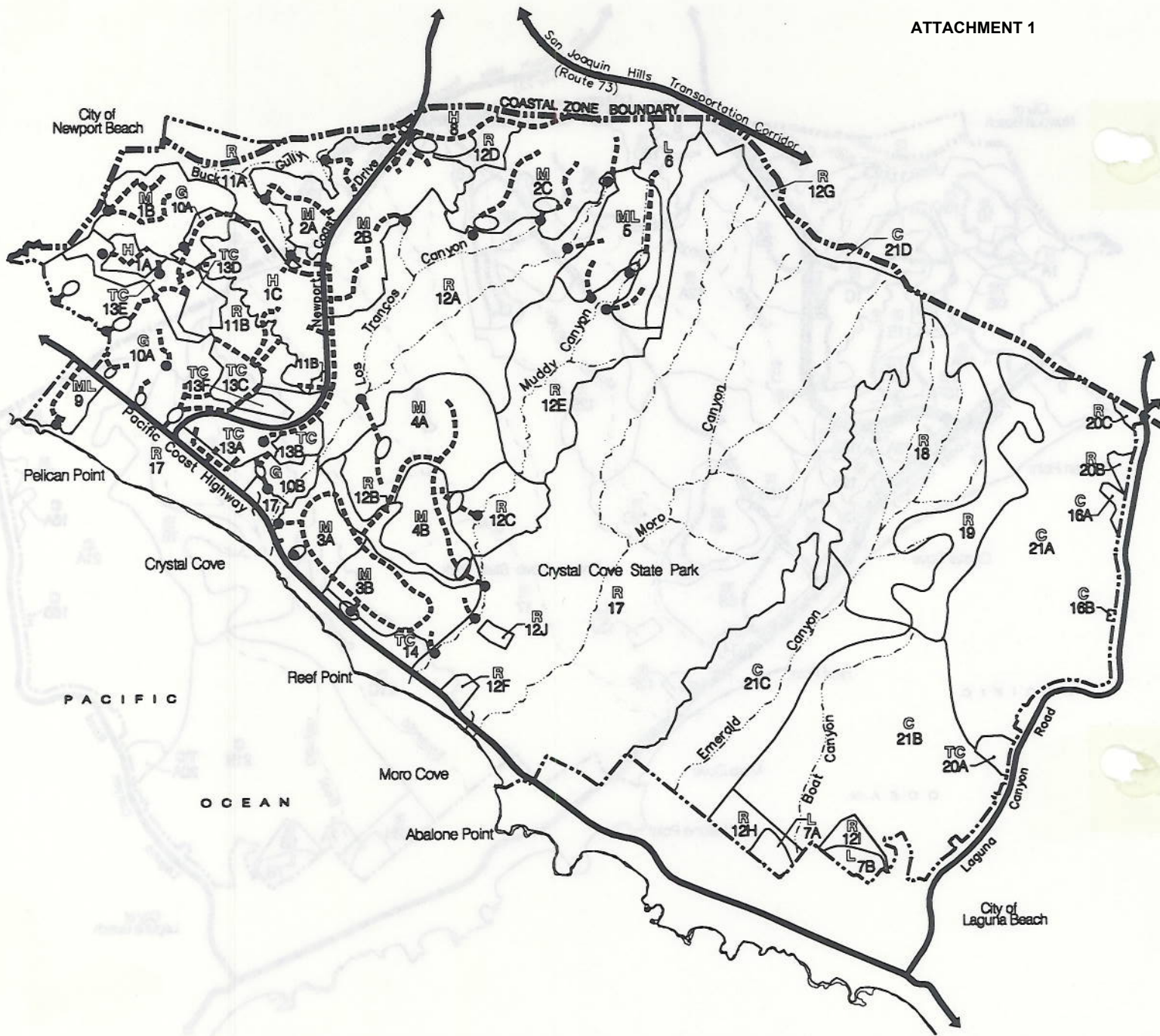

BACKBONE DRAINAGE CONCEPT - Second Amendment

Exhibit S

The Newport Coast Local Coastal Program

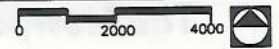

December 3, 1996

LEGEND

- STORM DRAIN
- ENERGY DISSIPATORS
- DETENTION BASINS
- COASTAL ZONE BOUNDARY
- PLANNED COMMUNITY BOUNDARY
- PLANNING AREA BOUNDARY
- 21A PLANNING AREA

This is a graphic representation of a planning/engineering concept. Final design solutions and precise locations for these facilities will be proposed and reviewed as part of subsequent plan approvals.

1
2
3
4
5
6
7
8
9
10
11
12
13
14
15
16
17
18
19
20
21
22
23
24
25
26
27
28

ORDINANCE NO. 096-3974

AN ORDINANCE OF THE COUNTY OF ORANGE, CALIFORNIA
APPROVING ZONE CHANGE 96-04, A PART OF THE
NEWPORT COAST LOCAL COASTAL PROGRAM

The Board of Supervisors of the County of Orange,
California, does ordain as follows:

SECTION 1. This Board hereby approves the attached Zone
Change No. 96-04 as considered by the Board on December 3, 1996.

OFFICE OF
COUNTY COUNSEL
ORANGE COUNTY

FC 10 (5/77)
GR

IMPLEMENTING ACTIONS PROGRAM PLANNED COMMUNITY DISTRICT REGULATIONS

CHAPTER 1 INTRODUCTION

The State of California Planning, Zoning and Development Laws of the Government Code, as articulated by the County of Orange Zoning Code and General Plan, require that all zoning be consistent with the General Plan and the Government Code.

The Newport Coast LCP Implementing Actions Program (IAP) is specifically designed to be consistent with and adequate to carry out the policies of the certified Newport Coast LCP Land Use Plan, and consists of the following Planned Community (PC) District Regulations and related provisions, procedures, definitions and descriptions, including the PC Zoning Map/Statistical Summary, the PC Development Map/Statistical Table, and referenced County of Orange Codes.

Development Element	Code	Area (Acres)	Maximum Allowed Accommodations Within Planned Community ¹
Townhouse Residential	TR	23	1,100
Single-Family Residential	SR	30	600
Medium-Density Residential	MR	37	1,700
High-Density Residential	HR	38	650
Office	OF	39	300
Professional Office	PO	14	0
Hotel/Motel	HM	30	150
Other	OT	17	
TOTAL COMMERCIAL		277	
TOTAL ACRES WITHIN PLANNED COMMUNITY		2,915	
MAXIMUM ALLOWED DWELLING UNITS WITHIN PLANNED COMMUNITY¹			2,900
MAXIMUM ALLOWED ACCOMMODATIONS WITHIN PLANNED COMMUNITY¹			2,150

Note: See Exhibit X, Planned Community Statistical Table, for more detailed information.

¹ The maximum accommodations for each development element will not be exceeded, but will be the total number of dwelling units and accommodations exceed the maximum permitted for the total Planned Community.

EXHIBIT T
SECOND AMENDMENT
PLANNED COMMUNITY STATISTICAL SUMMARY
Newport Coast Local Coastal Program

DEVELOPMENT INCREMENT	LAND USE	GROSS ACREAGE	Maximum Dwelling Units ¹	MAXIMUM ACCOMMODATIONS PER DEVELOPMENT INCREMENT ¹
1A,1B,1C,2A,2B,2C 3A,3B,4A,4B,5,6,7A,7B, 8,9	Residential			
TOTAL RESIDENTIAL		1,873	2,600 ¹	
10A,10B	Golf Course	354		
11A,11B, 12A,12B,12C,12D,12E,12F, 12G,12H,12I,12J	Recreation — Buck Gully, Los Trancos/ Muddy Canyon, Pelican/Wishbone Hill Areas	1,485		
17	Crystal Cove State Park	2,807		
18,19	Irvine Coast Wilderness Regional Park	677		
20B,20C	Recreation Parcels Adjacent Laguna Canyon Road	20		
21A,21B,21C,12D,16A,16B,	Conservation Irvine Coast Wilderness Regional Park	2,000		
TOTAL OPEN SPACE/RECREATION		7,343		
13A	Tourist Commercial	52		1,100 ¹
13B		30		600 ¹
13C		37		750 ¹
13D		38		650 ¹
13E		59		300 ¹
13F		14		0 ¹
14		30		250 ¹
20A		17		
TOTAL COMMERCIAL		277		
TOTAL Acres Within Planned Community		9,493		
MAXIMUM Allowed Dwelling Units Within Planned Community ¹			2,600 ¹	
MAXIMUM Allowed Accommodations Within Planned Community ¹				2,150 ¹

Note: See Exhibit X, Planned Community Statistical Table, for more detailed information.

¹ The maximum accommodations for each development increment will not be exceeded, nor will the total number of dwelling units and accommodations exceed the maximum permitted for the total Planned Community.

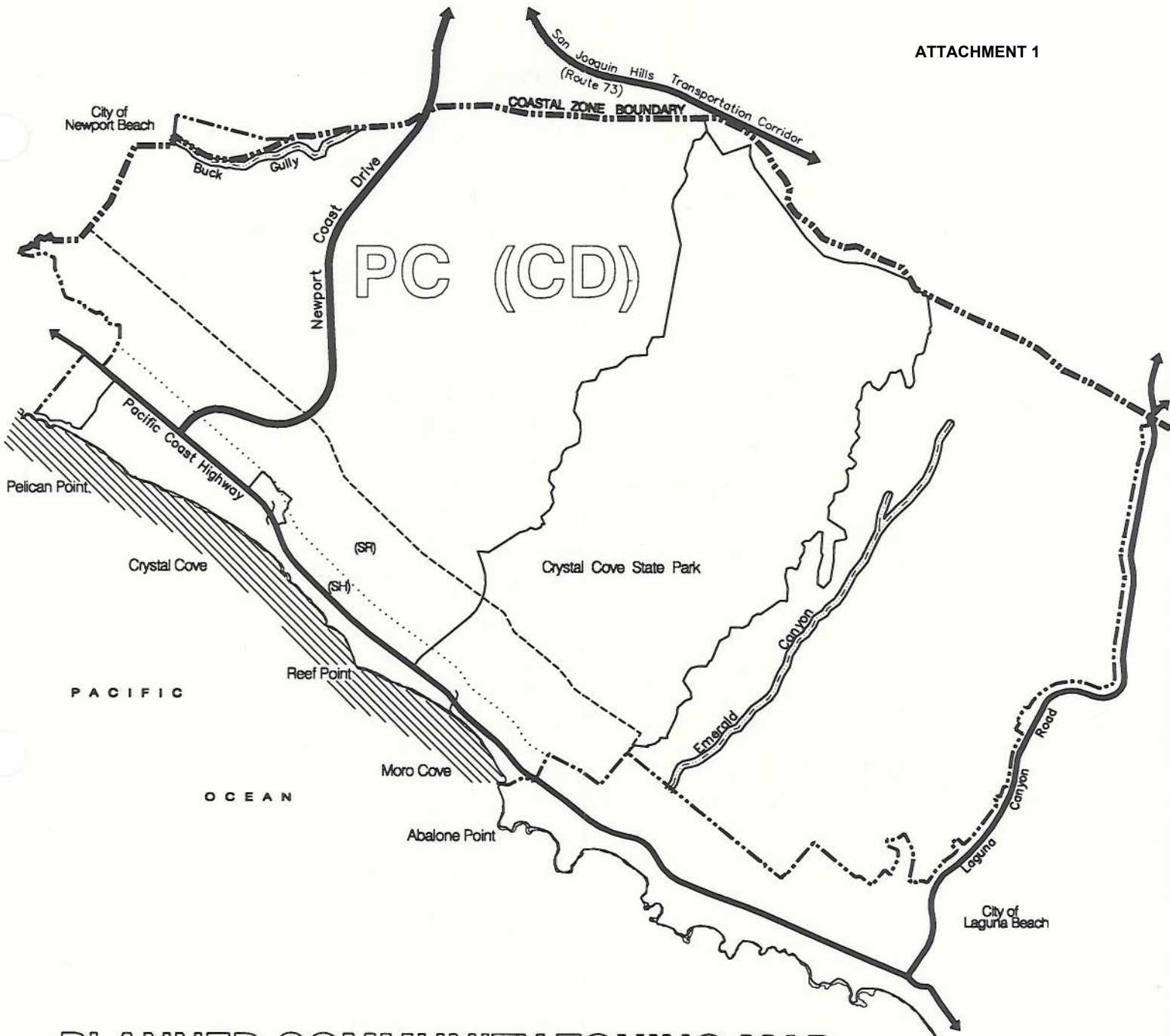

PLANNED COMMUNITY ZONING MAP Second Amendment

The Newport Coast Local Coastal Program

Exhibit U

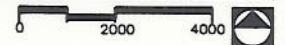

December 3, 1996

LEGEND

- | | |
|----------------------------|----------------------------|
| COASTAL ZONE BOUNDARY | PLANNED COMMUNITY DISTRICT |
| PLANNED COMMUNITY BOUNDARY | COASTAL DISTRICT |
| FLOOD PLAIN 2 | |
| FLOOD PLAIN 3 | |
| SCENIC HIGHWAY DISTRICT | |
| SIGN RESTRICTION DISTRICT | |

Note: See Exhibit W, Planned Community Development Map for more detailed information.



PLANNED COMMUNITY ZONING MAP
 Second Amendment

The Newport Coast Local Coastal Program



- LEGEND**
- COASTAL LINE BOUNDARY
 - PLANNED COMMUNITY BOUNDARY
 - FLOOD PLAINS
 - FLOOD PLAINS
 - BEACH HIGHWAY DISTRICT
 - OLD HIGHWAY DISTRICT
 - PLANNED COMMUNITY DISTRICT
 - COASTAL DISTRICT

For more information, please contact the Planning Department at Newport Beach, CA. Phone: (949) 546-1000. Website: www.newportbeach.gov

2. Purpose and Objectives

CHAPTER 2

PURPOSE AND OBJECTIVES

These regulations are intended to govern the conservation and development of The Newport Coast Planned Community as a coordinated, comprehensive project in order to use large-scale urban planning to create a superior environment to comply with Section 30513(a) of the California Coastal Act of 1976.

These regulations are consistent with and implement the General Plan and the Land Use Plan of The Newport Coast Planning Unit of the Local Coastal Program of the County of Orange. They are also intended to create a Newport Coast Planned Community Development Plan in compliance with Section 7-9-103, PC "Planned Community" District Regulations, of the County of Orange Zoning Code.

These regulations propose innovative community design and site planning concepts for development, while protecting and managing large open space areas (approximately 77 percent of the site) that will be preserved through this Planned Community. These regulations also establish a logical and timely sequence for governmental review of development proposals. Discretionary permits and procedures are summarized below, and described fully in Chapter 10.

A. COASTAL DEVELOPMENT PERMITS (CDP)

Coastal Development Permits are required in accordance with County of Orange Zoning Code Section 7-9-118. A CDP implements the California Coastal Act of 1976, as articulated by The Newport Coast Local Coastal Program, and may be processed as a large-scale plan. A detailed Site Plan may also be subsequently required for certain development projects.

B. ALTERNATIVE DEVELOPMENT STANDARDS

With approval of a CDP, alternative development standards may be established without an LCP amendment where the standards pertain to: setbacks to residential streets; nonresidential highways or local streets; rear and side yard setbacks for development not bordering an open space or

recreation area; building height (except for Planning Area PA 6) in areas not visible from Pacific Coast Highway; area per unit for residential inland of Pacific Coast Highway; walls and fences; landscaping other than along Pacific Coast Highway; signage; lighting; loading, trash and storage areas not visible from Pacific Coast Highway; vehicular driveways and sidewalks; outdoor storage areas; and/or modifications for off-street parking requirements in areas inland of Pacific Coast Highway. Alternative development standards other than those specified above will require an LCP amendment. Allowable variations in Planning Area boundaries and related matters are governed by the provisions of Chapter 11 of this IAP.

A CDP proposing to establish alternative development standards shall require a public hearing, with public notification, before the Planning Commission per Zoning Code Section 7-9-150.3(c) as adopted by the County at the time of Coastal Commission certification of this LCP.

When a Coastal Development Permit proposes to establish alternative development standards, the burden of proof shall be on the project proponent. The alternative development standards may be approved when it is found that they will result in an equivalent or better project in terms of minimizing adverse impacts and enhancing public benefits to the immediate and surrounding community.

C. PRINCIPAL PERMITTED USES

Land uses listed in this IAP as principal permitted uses are considered to be within the category of "Principal Permitted Use" under the County of Orange Zoning Code Section 7-9-118, the California Coastal Act of 1976, in general, and Public Resources Code Section 30603 (a) (4), in particular.

**3. General Provisions and
Regulations**

CHAPTER 3

GENERAL PROVISIONS AND REGULATIONS

A. GENERAL PROVISIONS

1. Except as specifically provided in this Implementing Actions Program, all construction and development within the project area shall comply with applicable provisions of the Uniform Building Code and the various related Mechanical, Electrical, Plumbing Codes, the Grading and Excavation Code, the Subdivision Code and Sign Code as currently adopted by the Board of Supervisors. In case of a conflict between those specific provisions and these regulations, the more restrictive shall prevail.
2. The building height requirements shall be as specified by each land use district of this Implementing Actions Program. The methods used for measuring building height shall be as stipulated in Chapter 12, Definitions, of this Implementing Actions Program.
3. All building sites shall comply with the provisions of the County of Orange Zoning Code Section 7-9-126, "Building Site Requirements".
4. All conditions, requirements, and standards, indicated graphically or in writing as part of any approved discretionary permit or detail plan granted by authority of these regulations shall have the same force and effect as these regulations. Any use or development established as a result of such approved permit or plan but not in compliance with all such conditions, requirements, or standards shall be in violation of this Implementing Actions Program. The enforcement provisions of Section 7-9-118.7 and Section 7-9-154 are applicable to this Implementing Actions Program.
5. The meaning and construction of words, phrases, titles and terms used in this Implementing Actions Program shall be the same as provided in Section 7-9-21, Definitions, of the Zoning Code except as otherwise specifically provided herein (see IAP Chapter 12, Definitions).

6. This Implementing Actions Program is intended to regulate all development within The Newport Coast. In cases where sufficient direction for interpretation of these regulations is not explicit in the approved Land Use Plan and Implementing Actions Program, the County of Orange Zoning Code shall provide direction as determined by the Director, EMA.
7. The provisions of Zoning Code Section 7-9-145, Off-Street Parking Regulations, are applicable to this Planned Community except where otherwise expressly listed as exceptions in Chapter 9, Off-Street Parking Regulations, of this Implementing Actions Program.
8. All discretionary actions permitted or required in this Planned Community shall be consistent with the types of permits listed in the CD "Coastal Development" District Regulation's Section 7-9-118 and Section 7-9-150 of the County of Orange Zoning Code.
9. An Annual Monitoring Report (AMR) shall be prepared and submitted in the fall of each year to the County of Orange Administrative Office and the Environmental Management Agency. The submittal of an AMR is required for conformance with the Growth Management Program of the Land Use Element of the County of Orange General Plan and the County's Annual Development Monitoring Program. The Board of Supervisors, in the annual adoption of the Development Monitoring Program, may identify significant imbalances between development projections and planned infrastructure or in the proportionate development of residential, commercial and employment land uses. The Board of Supervisors may defer subdivision approval within the Planned Community until approaches capable of resolving imbalances are proposed to and approved by the Board of Supervisors. The AMR will be the project proponent's opportunity to demonstrate mitigation measures and implementation strategies which will ensure adequate infrastructure for the community. With respect to Transportation/Circulation, this general provision may be implemented in such a manner as to reflect the provisions of a separate agreement as discussed in the LUP's Transportation/Circulation Policies Subsection I-4-E-22, provided that any such agreement is subsequently approved by the County and found by the County to be consistent with this Implementing Actions Program.

10. If any portion of these regulations is, for any reason, declared by a court of competent jurisdiction to be invalid or ineffective, in whole or in part, such decision shall not affect the validity of the remaining portions thereof. The Board of Supervisors hereby declares that it would have enacted these regulations and each portion thereof irrespective of the fact that any one or more portions be declared invalid or ineffective.

B. SPECIAL DEVELOPMENT REVIEW PROVISIONS

1. Residential development within The Newport Coast Planned Community shall be limited to a maximum of 2,600 dwelling units. Compliance with the County's Housing Element will be demonstrated in the Housing Implementation Plan. To implement the County's Housing Element, the Housing Implementation Plan (HIP) shall be submitted to and approved by the Director, EMA, prior to the recordation of final tract map(s) which include more than a cumulative total of 500 residential lots or units within The Newport Coast Planned Community¹.

2. PLANNING AREA/DWELLING UNITS/DENSITY PER ACRE:

- a. The dwelling units and density permitted in any residential density category, (e.g., Low Density) shall apply to the overall Planning Area in the Planned Community designated in such a residential density category and shall not be literally applied to any particular division of that area.
- b. Computation of acreage for determining density shall be based on gross area.

3. PLANNING AREA BOUNDARIES:

- a. Except as otherwise indicated, dimensions are measured from centerlines of streets and highways.

¹ Completed with the County's approval of the Affordable Housing Implementation Plan — First Amendment.

- b. When a Planning Area boundary depicted on the PC Development Map is also an arterial highway and the arterial highway is realigned, the Planning Area boundary may be revised to coincide with the realigned highway.
- c. Adjustments in Planning Area boundaries resulting in an acreage change of 10% or less of the total Planning Area for final street/highway alignments, landscaping requirements, Fire Protection Edge Treatments and/or Urban Edge Treatments, geotechnical or engineering refinements to Coastal Development Permits, Site Plans, and/or Tentative and/or Final Subdivision Maps shall not require amendment of the PC Zoning Map and/or Statistical Summary, provided the types or intensity of land uses for each Planning Area as approved in the LCP Land Use Plan and the maximum dwelling units and overnight/resort accommodations indicated in the Statistical Table are not altered and such adjustments are consistent with the LCP Land Use Plan.
- d. Final Planning Area boundaries shall be established by a Coastal Development Permit, and refined by the Site Plan and/or Tentative or Final Subdivision Map approval.

The boundary lines between Planning Areas within the same Land Use District may be adjusted, provided that the variation is consistent with the total acreage of Development and Open Space shown on the Planned Community (PC) Statistical Summary as provided for in Chapter 11 of this IAP, and does not result in development occurring within the proposed Irvine Coast Wilderness Regional Park dedication areas.

- e. Commercial and other nonresidential and residential uses and areas, to be located at intersections of streets or highways, shall be located to conform with final street or highway alignments without requiring an amendment of the Development Plan and Supplemental Text.
- f. The boundary between Planning Area PA 17 and Planning Areas PA 3B, PA 4B, PA 6, PA 12B, PA 12C, PA 12E, PA 14, and PA 21D is intended to reflect the legal boundary of Crystal Cove State Park.

4. **ENVIRONMENTALLY SENSITIVE HABITAT AREAS (ESHA'S):** Prior to, or coincidental with, the approval of any Coastal Development Permit for an area within 100 feet of an ESHA depicted on Exhibit H, compliance with LCP Land Use Plan, Environmentally Sensitive Habitat Area Policies Sections I-3-D, I-3-E, and I-3-F shall be demonstrated.
5. **GRADING:** Grading plans for all projects in The Newport Coast Planned Community shall be consistent with the County of Orange Grading Code and LCP Land Use Plan Grading Policies Section I-3-L. Grading plans shall be accompanied by geological and soil engineer reports, and shall incorporate all pertinent recommendations. The soils engineer and engineering geologist must certify the suitability of a graded site prior to clearance for issuance of a building permit. Grading will be permitted within The Planned Community outside of an area of immediate development provided that, a) grading shall be confined to the development planning areas shown on Exhibit F and, b) the Coastal Development Permit shows all areas of grading inside and outside of the immediate area of development. The landscape and grading plans shall include provisions for temporary erosion control consistent with LCP Land Use Plan requirements on all graded sites which are scheduled to remain unimproved between October 15 and April 15 of any year.
6. **ARCHAEOLOGICAL AND PALEONTOLOGICAL RESOURCES:** Prior to or coincidental with the approval of a Tentative Subdivision Map, except for Large-lot Subdivisions for financial or conveyance purposes, mitigation programs for archaeological and paleontological resources established in accordance with the Board of Supervisor's Archaeological/Paleontological Policies and the LCP Land Use Plan's Archaeological Policies Section I-3-G and Paleontological Policies Section I-3-H shall be submitted to and approved by the Manager, County of Orange EMA-Harbors, Beaches and Parks/Program Planning Division (HBP/PPD).
7. **DEVELOPMENT/OPEN SPACE BOUNDARY:** Tentative Subdivision Maps, Coastal Development Permits, or Site Plans abutting an Open Space Planning Area shall provide for the following either on the Map or on an appropriate supplemental graphic or text in a manner consistent with LCP Land Use Plan's Development/ Open Space Edges Policies Section I-3-M:

- a. **Urban Edge Treatment:** describing the interface treatment area between the urban and open space uses in a manner consistent with the LCP Land Use Plan;
 - b. **Fire Protection Edge Treatment,:** including any fuel breaks or fuel modification zones in a manner consistent with the LCP Land Use Plan and the County of Orange Fire Protection Planning Task Force Report; and
 - c. **Additional Information:** which the Manager, EMA HBP/PPD, deems necessary to assure consistency with the LCP Land Use Plan and any conditions of approval applying to The Newport Coast Planned Community.
8. **AGRICULTURE:** All existing and continuing grazing activities and uses, together with all accessory structures and uses which are customarily incidental or necessary to main buildings or uses, are permitted on an interim basis in accordance with LCP Land Use Plan's Resource Conservation and Management Policies in Chapter I-3.
 9. **AGRICULTURAL PRESERVE:** The terms of the Agricultural Preserve contract which apply to certain lands within this Planned Community shall remain in full force and effect until any such contract is canceled, expires, or is invalid under the Williamson Act as amended.
 10. **LOCAL PARKS:** Local Park Implementation shall be as set forth in the Local Park Implementation Plan contained in the LCP Appendix, Item 5 or subsequently approved amendments¹.
 11. **MASTER DRAINAGE AND RUNOFF MANAGEMENT PLAN:** As part of the review and approval of the first Coastal Development Permit(s), there shall be submitted to and approved by the Manager EMA Regulation, Development Services Division, a "Master Drainage and Runoff Management Plan" addressing in a comprehensive manner the following LUP Chapter 3 policy sections²:

¹ Completed with the County's approval of the Local Park Implementation Plan and subsequent amendment(s).

² A Master Drainage and Runoff Management Plan was approved by the County of Orange in December, 1989. Amendments will be prepared for all development projects located outside the area covered by this Master Plan.

- Section I - Erosion Policies;
- Section J - Sediment Policies;
- Section K - Runoff Policies;
- Section L - Grading Policies; and
- Section E - Category "C" ESHA (Marine Life Refuge).

Each of the above-noted policy sections shall be addressed in a comprehensive manner with respect to the proposed development including: 1) data on existing water quality and quantity; 2) assessment of project impacts on water resources, existing and proposed riparian habitats, and off-shore marine life; 3) identify mitigation measures and provide for implementation and long-term maintenance; and 4) monitoring program as determined necessary. The master drainage and RMP shall demonstrate conformance with the above-noted policies with specific emphasis on development impacts to the four sub-watershed/drainage areas summarized as follows and shown in Exhibit V:

- a. Development areas draining into Buck Gully;
- b. Development areas draining into Los Trancos Canyon;
- c. Residential, golf course, and resort areas draining across the frontal slopes of Pelican Hill and eventually discharging into existing drainages through Crystal Cove State Park; and
- d. Development areas draining into Muddy Canyon.

Conformance with LUP Chapter 3 Policy Sections I-L shall be assured for drainage into Buck Gully, Los Trancos Canyon, and Muddy Canyon. In addition to these policies, conformance with LUP Chapter 3 Policy Section E shall be required for development affecting drainage across the frontal slopes of Pelican Hill. The site-specific analyses shall provide a comprehensive overview of the physical improvements and control measures for all development areas draining into each of the above sub-watershed drainage areas. Accordingly, mass-grading plans shall be reflected in the site specific analyses and shall be related to the aforementioned physical improvements and control measures addressing LUP's Erosion, Sediment, Runoff, and Grading Policies. At least forty-five (45) days prior to any final County action on the Master Drainage and Runoff Management Plan, the proposed Plan shall be submitted to State Parks for review and comment. At the time of the approval of the CDP and any associated CEQA review for such development areas, specific findings shall be made regarding conformance with individual policy requirements.



SUB-WATERSHED AREAS for MASTER DRAINAGE and RUNOFF MANAGEMENT PLAN

The Newport Coast Local Coastal Program

Exhibit 1

NOT TO SCALE



December 3, 1998

- 12. EROSION CONTROL PLANS:** All Erosion Control Plans shall include provisions for temporary erosion control on all graded sites which are scheduled to remain unimproved between October 15th and April 15th of any year, consistent with LCP Land Use Plan's Erosion Policies Section I-3-I and Runoff Policies Section I-3-K.
- 13. WATER AND SEWER:** Water and sewer facilities shall be installed in accordance with an approved Plan of Public Works, prior to or concurrent with development.
- 14. ROAD STANDARDS:** Prior to or concurrent with the approval of any Tentative Subdivision Map, Coastal Development Permit, or Site Plan, modification to County of Orange Road Standards may be considered in accordance with the LCP Land Use Plan's Transportation/Circulation Policies Section I-4-E. Modifications to standards for local streets and collectors shall not require an LCP Amendment.
- 15. LOCAL STREET CONNECTIONS TO PACIFIC COAST HIGHWAY (PCH):** In addition to arterial highway intersections, all potential local street connections to PCH planned for PA 3A, PA 3B, PA 9, and PA 17 are shown conceptually on the Planned Community Development Map. The connection shown between PA 3B and PA 14 may be located in either of the two Planning Areas.
- 16. BLUFF-TOP SETBACKS FOR PLANNING AREA PA 9:** Primary structures in PA 9 will be sited consistent with Residential Policies Section I-4-D-3¹.
- 17. TRAIL REQUIREMENT FOR PLANNING AREA 9:** New development in PA 9 will provide an area for a bluff top public trail which connects to Crystal Cove State Park, in a manner capable of accommodating the trail improvements required as a condition of Coastal Development Permit No. 5-84-188 issued by the California Coastal Commission on November 27, 1984. It will complement a trail system similarly located within the State Park¹.

¹ The bluff top trail has been constructed.

- 18. TEMPORARY USES:** Temporary special community events, such as parades, pageants, golf tournaments, community picnics, athletic contests, swim meets, and other similar uses, may be permitted in any Planning Area, except Conservation and Recreation Planning Areas PA 18, PA 19, and PA 21 in The Newport Coast Planned Community, subject to approval by the Director, EMA.
- 19. LARGE-LOT SUBDIVISIONS:** Large-lot subdivisions, for the purpose of financing or conveyance, may be approved when no parcel is smaller than 20 acres; provided the Subdivision or Parcel Map related thereto includes a declaration that the lots created are not building sites. This includes the subdivision of commercial visitor-serving (i.e., Tourist-Commercial) use areas. Installation of infrastructure improvements shall not be made a condition of approval of these large-lot subdivisions but all parcels shall be subject to any overall grading, drainage, and erosion control conditions required to assure conformity with the LCP at the time of issuance of the Coastal Development Permit for the large-lot subdivision.
- 20. ANNEXATION/INCORPORATION:** In the event of application for annexation or incorporation of all or part of The Newport Coast Planned Community, a revised Fiscal Impact Report shall be prepared by the petitioners to assess the cost/revenue impact of such annexation or incorporation on the County and on the special districts serving the property to be annexed or incorporated.
- 21. FLOODPLAIN DISTRICT:** The FP "Floodplain" District Regulations will apply to The Newport Coast Planned Community in accordance with Section 7-9-48 and Section 9-9-113 of the County Zoning Code.
- 22. SCENIC HIGHWAY DISTRICT:** The SH "Scenic Highway" District regulations will apply to The Newport Coast Planned Community in accordance with Section 7-9-119 of the County Zoning Code, except that a Coastal Development Permit, where otherwise required, may be processed in lieu of a Site Development Permit.

23. **ULTIMATE HIGHWAY ALIGNMENT:** The ultimate Highway alignment for Newport Coast Drive shall reflect geotechnical and environmental factors and shall be in substantial conformance with the alignment shown in Exhibit L.
24. **IRS BLOCKS:** The Newport Coast Planned Community encompasses all or portions of the following IRS Blocks 96, 129, 130, 131 A&B, 132, 133, 134, 161, 163, 164 A&B, 165, 166, 167, 181, 182, 183, and 185.
25. **PUBLIC UTILITIES:** Public utility buildings, structures, and facilities including, but not limited to, electrical, water sewage, telephone, and television, and their storage, distribution, treatment and/or production required to carry out development allowed in the LUP are permitted in planning areas in conformance with the LCP Land Use Plan's Policies Chapters 3 and 4.
26. **FIRE STATION:** Prior to the recordation of the first development map inland of PCH, the developer shall enter into an agreement with the County of Orange that includes the following
- a. The developer shall offer for dedication a site in the vicinity of Newport Coast Drive and the San Joaquin Hills Transportation Corridor to be specifically used for a fire station. Said location shall be to the satisfaction of the Manager of Fire Services of the Orange County Fire Department¹.
 - b. The developer shall participate proportionately in the construction of said fire station in a manner identified by the Manager of Fire Services of the Orange County Fire Department and approved by the Board of Supervisors.
27. **LAGUNA CANYON ROAD:** Improvements to accommodate the widening and/or relocation of Laguna Canyon Road shall be allowed in PA 16A, PA 16B, PA 20A, PA 20B, PA 20C, PA 21A, and PA 21B, provided that any such project is the least environmentally damaging feasible alternative, as determined and approved by the California Coastal Commission.

¹ Completed.

23. ULTIMATE HIGHWAY ALIGNMENT: The ultimate Highway alignment for Newport Coast Drive shall reflect geotechnical and environmental factors and shall be in substantial conformance with the alignment shown in Exhibit I.

24. IRS BLOCKS: The Newport Coast Planned Community encompasses all or portions of the following IRS blocks 95, 122, 130, 131 A&B, 132, 133, 134, 141, 143, 144 A&B, 145, 146, 147, 148, 149, 153, and 155.

25. PUBLIC UTILITIES: Public utility holdings, structures, and facilities including, but not limited to, electrical, water, sewer, telephone, and television, and their storage, distribution, treatment and/or production required to carry out development allowed in the LUP are retained in planning areas in conformance with the LUP. Land Use Plan's Policies Chapters 3 and 4.

26. FIRE STATION: Prior to the recording of the first development map issued by FCH, the developer shall enter into an agreement with the County of Orange that includes the following:

a. The developer shall offer for dedication a site in the vicinity of Newport Coast Drive and the San Juan Hills Transportation Corridor to be specifically used for a fire station. Said location shall be to the satisfaction of the Manager of Fire Services of the Orange County Fire Department.

b. The developer shall participate proportionately in the construction of said fire station in a manner identified by the Manager of Fire Services of the Orange County Fire Department and approved by the Board of Supervisors.

27. LAGUNA CANYON ROAD: Improvements to accommodate the widening and/or relocation of Laguna Canyon Road shall be allowed in PA 16A, PA 16B, PA 16C, PA 20A, PA 20B, PA 20C, PA 21A, and PA 21B, provided that any such project is the least environmentally damaging feasible alternative, as determined and approved by the California Coastal Commission.

CHAPTER 4

RESIDENTIAL PLANNING AREAS

A. LOW DENSITY RESIDENTIAL PLANNING AREAS PA6, PA 7A, AND PA 7B

1. PURPOSE AND INTENT:

The Low Density Residential Planning Areas of The Newport Coast Planned Community are established to provide for a range of single-family detached housing and lot sizes, as well as recreation uses, community facilities, community service facilities, and other uses and structures accessory to the principal uses. These Low Density Residential Planning Area Regulations are intended to implement the LCP Land Use Plan's Residential Policies Section I-4-D, and are subject to the requirements of the LCP Land Use Plan's Policies in Chapters 3 and 4.

2. PRINCIPAL AND OTHER PERMITTED USES:

The following principal and other permitted uses are permitted in all Planning Areas designated for Low Density Residential use subject to the approval of a Coastal Development Permit as provided in Chapter 10:

a. Principal Permitted Uses Subject to Zoning Administrator Approval:

- 1) Detached single-family dwellings.
- 2) Community care facilities serving twelve (12) or fewer persons per Zoning Code Section 7-9-141.
- 3) Community facilities, including the following uses, and related and similar uses:
 - a) Intra-community directional signs.
 - b) Public and private parks (non-commercial).

- c) Public and private (non-commercial) recreation centers and facilities including, but not limited to, swimming pools, tennis courts, and clubhouses.
 - d) Riding, hiking, and bicycle trails.
 - e) Security and maintenance facilities related directly to the residential community.
- 4) Communication transmitting, reception or relay facilities.

b. Principal Permitted Uses Subject to Planning Commission Approval:

- 1) Community and community service facilities including the following uses, and related and similar uses:
 - a) Community centers.
 - b) Community information centers.
- 2) In PA 6, equestrian centers limited to 50 horses maximum.
- 3) Residential Planned Developments per Zoning Code Section 7-9-110.

c. Other Permitted Uses Subject to Planning Commission Approval (these uses are appealable to the California Coastal Commission per County Zoning Code Section 7-9-118.6 (4) b):

- 1) Community and community service facilities including the following uses, and related and similar uses:
 - a) Churches.
 - b) Fire stations.
 - c) Schools.
 - d) Public and private day care/nursery schools.

3. ACCESSORY PERMITTED USES:

Accessory uses and structures are permitted when customarily associated with and subordinate to a Permitted Use on the same building site, per Zoning Code Section 7-9-137 except as modified in Subsection 6 of this Section, including:

- a. Garages and carports;
- b. Detached accessory structures such as greenhouses, gazebos, cabanas, and storage sheds;
- c. Swimming pools, therapy baths, water fountains, and related equipment;
- d. Covered patios and decks;
- e. Fences and walls;
- f. Tennis courts, parks, trails, greenbelts, and common areas;
- g. One guest cottage or caretaker unit per building site, limited to 1,500 square feet; on building sites of a minimum 10,000 square feet;
- h. Signs per Zoning Code Section 7-9-144;
- i. Noncommercial keeping of pets and animals per Zoning Code Section 7-9-146.3;
- j. Home occupations per Zoning Code Section 7-9-146.6; and
- k. Non-commercial/non-profit art displays and galleries.

4. TEMPORARY PERMITTED USES:

Temporary uses are permitted in Residential Planning Areas subject to the requirements of County of Orange Zoning Code Section 7-9-136, Temporary Uses and Structures, and consistency with the LCP Land Use Plan.

5. PROHIBITED USES:

- a. The storage of vehicles, equipment, or products related to a commercial activity not permitted in this area;
- b. The keeping of pets or animals for any commercial purpose;
- c. Apiaries;
- d. Industrial and manufacturing facilities; and
- e. Uses not provided by Subsection 2 through 4 of this Section shall be prohibited, however it is recognized that certain permitted uses are only defined generally and may require interpretation by the Director, EMA, per Zoning Code Section 7-9-20.

6. SITE DEVELOPMENT STANDARDS:

a. Building site area:

- 1) In PA 6, PA 7A, and PA 7B: Thirty thousand (30,000) square feet minimum.

b. Building site width: No minimum.

- ##### c. Building height: Thirty-five (35) feet maximum, except special height provisions may apply to Planning Area PA 6 pursuant to LUP Subsection I-4-D-4e.

d. **Building site coverage:** Fifty (50) percent maximum.

e. **Building setbacks:**

- 1) From any street: Ten (10) feet minimum except garages and carports per Subsection 7 below.
- 2) Side: Ten (10) feet minimum for one side only, or ten (10) feet aggregate total for both sides.
- 3) Rear: Ten (10) feet minimum.
- 4) Patios: No attached or detached covered patio shall be located closer than three (3) feet to a property line except the street-side property line of a corner lot, in which case a minimum distance of ten (10) feet shall be maintained.
- 5) Projections into required setbacks: Eaves, cornices, chimneys, balconies, and other similar architectural features may project a maximum of six (6) feet into any required front, rear, or side setback.
- 6) Miscellaneous provisions and exceptions unless otherwise specified:
 - a) Attached accessory buildings shall be considered as a part of the main building; and
 - b) Detached accessory buildings shall be located no closer than the setback required for the main building.
- 7) Garage and carport placement: The point of vehicular entry to a garage or carport shall be a minimum distance of seven (7) feet or less, or twenty (20) feet or more from the back of sidewalk, or, if there is no sidewalk, from back of curb.

- f. **Fences and walls, maximum height provided that, for vehicular safety purposes, site distances are not obstructed:**
- 1) Within areas where main buildings may be placed: ten (10) feet maximum, except for entry gates and other ornamental and architectural features, which may be a maximum of twenty-five (25) feet.
 - 2) Within front setback area: six (6) feet maximum.
 - 3) Within other setback areas: the maximum height shall be six (6) feet, except that this maximum may be exceeded when higher walls are required by the Director, EMA, for the purpose of noise mitigation or other health and safety measures.
- g. **Off-street parking:** Shall be provided per Chapter 9 of this IAP.
- h. **Lights:** All lights shall be designed and located so that light rays are aimed at the site.
- i. **Grading:** Shall occur in areas averaging less than 30% slopes unless there are no other feasible, less environmentally damaging alternatives.
- j. **Standards for local roads,** including gradients, width, radius of curvature, and lighting, shall ensure that visual impact is minimized.
- k. **Areas of disturbed soil** shall be hydro-seeded with native or non-intrusive non-native plants to control erosion.
- l. **Manufactured slopes along development edges** shall incorporate contour grading techniques.
- m. **Compliance with LUP Residential Policy Subsection I-4-D-4e,** will be demonstrated through a Viewshed Analysis.

B. MEDIUM-LOW DENSITY RESIDENTIAL PLANNING AREAS PA 5 AND PA 9**1. PURPOSE AND INTENT:**

The Medium-Low Density Residential Planning Areas of the Newport Coast Planned Community are established to provide for a variety of residential uses including predominantly smaller lot single-family attached, patio home, townhome, and duplex housing types, as well as larger single-family detached housing types, recreation uses, community facilities, community service facilities, and other uses and structures accessory to the principal uses. These Medium-Low Density Residential Planning Area Regulations are intended to implement the LCP Land Use Plan's Residential Policies Section I-4-D, and are subject to the requirements of the LCP Land Use Plan's Policies in Chapters 3 and 4.

2. PRINCIPAL AND OTHER PERMITTED USES:

The following principal and other permitted uses are permitted in all Planning Areas designated for Medium-Low Density Residential use subject to the approval of a Coastal Development Permit as provided in Chapter 10:

a. Principal Permitted Uses Subject to Zoning Administrator Approval:

- 1) Detached single-family dwellings.
- 2) Community care facilities serving twelve (12) or fewer persons per Zoning Code Section 7-9-141.
- 3) Community facilities including the following uses, and related and similar uses:
 - a) Intra-community directional signs.
 - b) Public and private parks (non-commercial).
 - c) Public and private (non-commercial) recreation centers and facilities including, but not limited to, swimming pools, tennis courts and clubhouses.
 - d) Riding, hiking, and bicycle trails.

- e) Security and maintenance facilities related directly to the residential community.
- 4) Attached single family dwellings and duplexes, except planned developments.
- 5) Only if golf course play is extended into PA 9, and then for PA 9 only, the residential uses permitted in this Section will be allowed in combination with uses permitted in Section II-6-B-1a/d (Golf Courses/ Clubhouse Facilities) and II-6-B-2 (Accessory Permitted Uses) subject to the requirements of Section II-6-E-2 through II-6-E-8 (Golf Course Site Development Standards), a maximum building height of 28 feet, and a maximum of 10,000 square feet (gross) for golf course/clubhouse facilities (the square footage of such facilities shall be included within the maximum square feet limitation for all Tourist Commercial facilities for PA 13 as provided in Chapter II-5).
- 6) Communication transmitting, reception or relay facilities.
- 7) Accessory Permitted Uses referenced in Subsection 3 of this Section when located on a separate building site.

b. Principal Permitted Uses Subject to Planning Commission Approval:

- 1) Community and community service facilities including the following uses, and related and similar uses:
 - a) Community centers.
 - b) Community information centers.
- 2) In PA 5, equestrian centers limited to 50 horses maximum.
- 3) Residential Planned Developments per Zoning Code Section 7-9-110.
- 4) Residential condominiums and stock cooperatives per Zoning Code Section 7-9-147.

c. **Other Permitted Uses Subject to Planning Commission Approval (these uses are appealable to the California Coastal Commission per County Zoning Code Section 7-9-118.6 (4) b):**

1) Community and community service facilities including the following uses, and related and similar uses:

- a) Churches.
- b) Fire stations.
- c) Schools.
- d) Public and private day care/nursery schools.

3. ACCESSORY PERMITTED USES:

Accessory uses and structures are permitted when customarily associated with and subordinate to a Permitted Use on the same building site, per Zoning Code Section 7-9-137 except as modified in Subsection 6 of this Section, including:

- a. Garages and carports;
- b. Detached accessory structures such as greenhouses, gazebos, cabanas, and storage sheds;
- c. Swimming pools, therapy baths, water fountains, and related equipment;
- d. Covered patios and decks;
- e. Fences and walls;
- f. Tennis courts, parks, trails, greenbelts, and common areas;
- g. One guest cottage or caretaker unit per building site, limited to 1,500 square feet; on building sites of a minimum 10,000 square feet;

- h. Signs per Zoning Code Section 7-9-144;
- i. Noncommercial keeping of pets and animals per Zoning Code Section 7-9-146.3;
- j. Home occupations per Zoning Code Section 7-9-146.6; and
- k. Non-commercial/non-profit art displays and galleries.

4. TEMPORARY PERMITTED USES:

Temporary uses are permitted in Residential Planning Areas subject to the requirements of County of Orange Zoning Code Section 7-9-136, Temporary Uses and Structures, and consistency with the LCP Land Use Plan.

5. PROHIBITED USES:

- a. The storage of vehicles, equipment, or products related to a commercial activity not permitted in this area;
- b. The keeping of pets or animals for any commercial purpose;
- c. Apiaries;
- d. Industrial and manufacturing facilities; and
- e. Uses not provided by Subsection 2 through 4 of this Section shall be prohibited, however it is recognized that certain permitted uses are only defined generally and may require interpretation by the Director, EMA, per Zoning Code Section 7-9-20.

6. SITE DEVELOPMENT STANDARDS:

- a. **Building site area:** Three thousand (3,000) square feet minimum for condominium and stock cooperative; two thousand five hundred (2,500) square feet minimum for detached and attached single-family, duplex, and other (nonresidential) developments.
- b. **Building site width:** No minimum.
- c. **Building height:** Thirty-five (35) feet maximum, except twenty-eight (28) feet maximum in PA 9.
- d. **Building site coverage:** Fifty (50) percent maximum.
- e. **Building setbacks:**
 - 1) From any street, ten (10) feet minimum, except garages and carports per Subsection 6 below.
 - 2) From any side or rear property line not abutting a street, no minimum.
 - 3) Patios: No attached or detached covered patio shall be located closer than three (3) feet to a property line except the street side property line of a corner lot, in which case a minimum distance of ten (10) feet shall be maintained. Covered patios may be completely screened, including all exterior walls and ceilings, with full ventilating screen.
 - 4) Projections into required setbacks: Eaves, cornices, chimneys, balconies and other similar architectural features may project a maximum of six (6) feet into any required front, rear, or side setback.
 - 5) Miscellaneous provisions and exceptions unless otherwise specified:

- a) Attached accessory buildings shall be considered as a part of the main buildings; and
 - b) Detached accessory buildings shall be located no closer than the setback required for the main building.
- 6) Garage and carport placement: The point of vehicular entry to a garage or carport shall be a minimum distance of seven (7) feet or less, or twenty (20) feet or more from the back of sidewalk, or, if there is no sidewalk, from back of curb.
- f. **Fences and walls, maximum height provided that site distances for vehicular safety purposes are not obstructed:**
- 1) Within areas where main buildings may be placed: eight (8) feet maximum.
 - 2) Within front setback area: six (6) feet maximum.
 - 3) Within other setback areas: The maximum height shall be six (6) feet, except that this maximum may be exceeded when higher walls are required by the Director, EMA, for the purpose of noise mitigation or other health and safety measures.
- g. **Off-street parking:** Shall be provided per Chapter 9 of this IAP.
- h. **Lights:** All lights shall be designed so that all rays are aimed at the site.
- i. **Standards for local roads,** including gradients, width, radius of curvature and lighting shall ensure that visual impact is minimized where feasible.
- j. **Areas of disturbed soil** shall be hydro-seeded with native or non-intrusive non-native plants to control erosion.
- k. **Manufactured slopes along development edges** shall incorporate contour grading techniques.

C. MEDIUM AND HIGH DENSITY RESIDENTIAL PLANNING AREAS PA 1B, PA 2A, PA2B, PA 2C, PA 3A, PA 3B, PA 4A, PA 4B AND PA 1A, PA 1C, PA 8

1. PURPOSE AND INTENT:

The Medium and High Density Residential Planning Areas of The Newport Coast Planned Community are established to provide for predominantly multiple-family housing while also permitting the various single-family detached/attached and duplex housing types and uses, as well as recreation uses, community facilities, community service facilities, and other uses and structures accessory to the principal uses. These Medium and High Density Residential Planning Area Regulations are intended to implement the LCP Land Use Plan's Residential Policies Section I-4-D, and are subject to the requirements of the LCP Land Use Plan's Policies in Chapters 3 and 4.

2. PRINCIPAL AND OTHER PERMITTED USES:

The following principal and other permitted uses are permitted in all Planning Areas designated for Medium and High Density Residential use subject to the approval of a Coastal Development Permit as provided in Chapter 10:

a. Principal Permitted Uses Subject to Zoning Administrator Approval:

- 1) Detached single-family dwellings.
- 2) Community care facilities serving twelve (12) or fewer persons per Zoning Code Section 7-9-141.
- 3) Community facilities including the following uses, and related and similar uses:
 - a) Intra-community directional signs.
 - b) Public and private parks (non-commercial).
 - c) Public and private (non-commercial) recreation centers and facilities including, but not limited to, swimming pools, tennis courts, and clubhouses.

- d) Riding, hiking, and bicycle trails.
 - e) Security and maintenance facilities related directly to the residential community.
- 4) Attached single family dwellings and duplexes, except planned developments.
 - 5) Accessory Permitted Uses referenced in Subsection 3 of this Section when located on a separate building site.
 - 6) Multiple-family residential developments of four (4) units or less.
 - 7) Community transmitting, reception or relay facilities.

b. Principal Permitted Uses Subject to Planning Commission Approval:

- 1) Community and community service facilities including the following uses, and related and similar uses:
 - a) Community centers.
 - b) Community information centers.
- 2) Residential Planned Developments per Zoning Code Section 7-9-110.
- 3) Multiple-family residential developments of five (5) units or more, except condominiums and stock cooperatives, per Zoning Code Section 7-9-146.7.
- 4) Residential condominiums and stock cooperatives per Zoning Code Section 7-9-147.
- 5) One (1) neighborhood commercial site within Planning Areas PA 1C, PA 2A, PA 2B, PA 3A, PA 3B or PA 8 per standards in Zoning Code Section 7-9-89 and the requirements of the LCP Land Use Plan's Policies in Chapters 3 and 4, provided that the site shall not exceed ten (10) gross acres and a maximum building floor area of 100,000 square feet.

c. Other Permitted Uses Subject to Planning Commission Approval (these uses are appealable to the California Coastal Commission per County Zoning code Section 7-9-118.6 (4) b):

1) Community and community service facilities including the following uses, related and similar uses:

- a) Churches.
- b) Fire stations.
- c) Schools.
- d) Public and private day care/nursery schools.

3. ACCESSORY PERMITTED USES:

Accessory uses and structures are permitted when customarily associated with and subordinate to a Permitted Use on the same building site, per Zoning Code Section 7-9-137 except as modified in Subsection 6 of this Section, including:

- a. Garages and carports;
- b. Detached accessory structures such as greenhouses, gazebos, cabanas, and storage sheds;
- c. Swimming pools, therapy baths, water fountains, and related equipment;
- d. Covered patios and decks;
- e. Fences and walls;
- f. Tennis courts, parks, trails, greenbelts, and common areas;
- g. One guest cottage or caretaker unit per building site, limited to 1,500 square feet; on building sites of a minimum 10,000 square feet;

- h. Signs per Zoning Code Section 7-9-144;
- i. Noncommercial keeping of pets and animals per Zoning Code Section 7-9-146.3;
- j. Home occupations per Zoning Code Section 7-9-146.6; and
- k. Non-commercial/non-profit art displays and galleries.

4. TEMPORARY PERMITTED USES:

Temporary uses are permitted in Residential Planning Areas subject to the requirements of County of Orange Zoning Code Section 7-9-136, Temporary Uses and Structures, and consistency with the LCP Land Use Plan.

5. PROHIBITED USES:

- a. The storage of vehicles, equipment, or products related to a commercial activity not permitted in this area;
- b. The keeping of pets or animals for any commercial purpose;
- c. Apiaries;
- d. Industrial and manufacturing facilities; and
- e. Uses not provided by Subsection 2 through 4 of this Section shall be prohibited, however it is recognized that certain permitted uses are only defined generally and may require interpretation by the Director, EMA, per Zoning Code Section 7-9-20.

6. SITE DEVELOPMENT STANDARDS:

- a. **Building site area:** Three thousand (3,000) square feet minimum for condominium, stock cooperative, and apartment developments; Two thousand five hundred (2,500) square feet minimum for detached and attached single-family, duplex, and other (nonresidential) developments.
- b. **Area per unit:** One thousand (1,000) square feet minimum gross land area per dwelling unit, regardless of the slope of the land.
- c. **Building site width:** No minimum.
- d. **Building height:** Thirty-five (35) feet maximum except forty-five (45) feet maximum for Planning Area 8.
- e. **Building site coverage:** No maximum.
- f. **Building setbacks:** Ten (10) feet minimum from any exterior property line or property line abutting a public or private street, except garages and carports per Subsection G below. From any other interior property line, no minimum. In PA 3A and PA 3B, the building setback from Pacific Coast Highway will be a minimum 100-feet for landscaping and buffering purposes.
- g. **Garage and carport placement:** The point of vehicular entry to a garage or carport shall be a distance of seven (7) feet or less, or twenty (20) feet or more from the back of sidewalk, or if there is no sidewalk, from back of curb.
- h. **Off-street parking:** Shall be provided per Chapter 9 of this IAP.
- i. **Open space (except for single family developments):** Minimum of five percent (5%) of the net area of the project is to be reserved as usable open space. The following shall not be counted in computing the usable open space: streets, common driveways, slopes greater

than 2.5:1 incline, and any property not reserved for the sole use and enjoyment of the occupants of the project and their guests.

j. Trash and storage areas (except for single family developments): All storage, including cartons, containers or trash shall be shielded from view within a building or area enclosed by a wall not less than six (6) feet in height.

k. Screening (except for single family developments):

1) **Abutting residential areas:** A screen shall be installed as required to buffer multiple-family developments from abutting areas zoned for single-family residential. Except as otherwise provided below, the screening shall have a total height of not less than six (6) feet and not more than seven (7) feet. Where there is a difference in elevation on opposite sides of the screen, the height shall be measured from the highest point of elevation.

2) **Parking areas abutting arterial highways:** An opaque screen shall be installed along all parking areas abutting arterial highways. Except as otherwise provided below, the screening other than landscaping shall have a total height of not less than three (3) feet and not more than six (6) feet.

3) Notwithstanding the requirements listed above, where the finished elevation of the property at the boundary line, or within five (5) feet inside the boundary line, is higher or lower than an abutting property elevation, such change in elevation may be used in lieu of, or in combination with, additional screening to satisfy the screening requirements of this Section.

4) A screen as referred to in Subsection 1, 2, and 3 above, shall consist of one or any combination of the following:

a) **Walls including retaining walls:** A wall shall consist of concrete, stone, brick, tile or similar type of solid masonry material a minimum of four (4) inches thick.

- b) Berms: A berm shall be constructed of earthen materials and it shall be landscaped.
 - c) Fences, solid: A solid fence shall be constructed of wood, or other materials a minimum nominal thickness of one (1) inch.
 - d) Landscaping: Vegetation shall consist of evergreen or deciduous trees or shrubs.
- l. Landscaping (except for single family developments)**: The planting of drought tolerant, native or non-intrusive non-native low maintenance species is encouraged. Landscaping, consisting of evergreen or deciduous trees, shrubs, groundcover, and/or hardscape shall be installed and maintained subject to the following standards:
- 1) Boundary landscaping abutting arterial highways is required to a minimum depth of ten (10) feet.
 - 2) Boundary landscaping abutting public streets, other than arterial highways, is required to an average depth of ten (10) feet with a minimum depth of five (5) feet.
 - 3) Separation: Any landscaped area shall be separated from an adjacent vehicular area by a wall or curb at least six (6) inches higher than the adjacent vehicular area or in some manner be protected from vehicular damage.
 - 4) Watering: Watering facilities shall be provided for all landscaped areas except where drought tolerant species have been established.
 - 5) Maintenance: All landscaping shall be maintained in a neat, clean and healthy condition. This shall include proper pruning, mowing of lawns, weeding, removal of litter, fertilizing, replacement of plants when necessary and the watering of all plantings per Subsection 4 above.
- m. Lights** All lights shall be designed and located so that rays are aimed at the site.
- n. Standards for local roads**, including gradients, width, radius of curvature and lighting shall ensure that visual impact is minimized where feasible.

- o. Areas of disturbed soil** shall be hydro-seeded with native or non-intrusive non-native plants to control erosion.
- p. Manufactured slopes along development edges** shall incorporate contour grading techniques.

CHAPTER 5

TOURIST COMMERCIAL PLANNING AREAS

A. PURPOSE AND INTENT

The Tourist Commercial Planning Areas of The Newport Coast Planned Community are established to provide for the development and maintenance of destination resort and related tourist/recreational visitor-serving facilities, cultural, community and community services facilities, and accessory uses and structures, in proximity to Crystal Cove State Park and major beach areas. These Tourist Commercial Planning Area Regulations are intended to implement the LCP Land Use Plan's Tourist Commercial Policies Section I-4-A subject to the requirements of the LCP Land Use Plan's Policies in Chapters 3 and 4. In addition to the site development regulations provided below, individually-owned accommodations (e.g., casitas and time-sharing condominiums) in the destination resort shall be developed pursuant to the Subdivision Code and/or other County and State regulations applicable to the type of accommodation units being developed.

B. PRINCIPAL PERMITTED USES

The following principal permitted uses are permitted in all Planning Areas designated for Tourist Commercial use subject to the approval of a Coastal Development Permit as provided in Chapter 10:

1. PRINCIPAL PERMITTED USES SUBJECT TO PLANNING COMMISSION APPROVAL:

- a. A destination resort and other commercial recreation uses, as defined in the LUP and Chapter 12, Definitions, of this IAP (Planning Areas PA 13A, PA 13B, PA 13C, PA 13D, PA 13E, PA 13F, PA 14 and PA 20A), comprising the following types of visitor-serving uses.
 - 1) Overnight/resort visitor accommodations not to exceed two thousand one hundred and fifty (2,150) accommodations (e.g., hotel rooms, motel rooms, casitas, time-sharing condominiums, etc.). Within Planning Areas PA 13A-13F and PA 14, there shall be

a maximum of 2,150 overnight/resort accommodation units. Of this total, (1) no more than 1,800 units may be individually owned; and (2) at least 350 units shall be hotel, motel or other non-individually owned, non-timesharing condominium resort accommodations. Coastal Development Permits for individually owned and timesharing condominium overnight/resort accommodations shall be conditioned to require contracting with a management company or companies to supply rental services to the project (e.g., advertising of units to the general public, taking reservations for the general public, housecleaning, guest check-in, security, etc.).

- 2) Retail and service commercial.
 - 3) Parking structures.
 - 4) Conference, convention, and other ancillary facilities.
 - 5) Restaurants.
 - 6) Cocktail lounges and bars.
 - 7) Commercial recreation uses.
 - 8) Health facilities.
 - 9) Public and private golf courses and related facilities.
 - 10) Service Stations per Zoning Code Section 7-9-114.
 - 11) Helistops and heliports to be used for shuttle transportation only.
 - 12) Other uses ancillary to a destination resort.
- b. Cultural facilities including but not limited to museums, art galleries/exhibits, and theaters.

- c. Visitor-oriented day-use retail and service commercial totaling not more than 75,000 square feet in PA 13A through PA 13F, and not more than 25,000 square feet in PA 14.
- d. Visitor-oriented retail commercial, service commercial, public works facilities and commercial recreation, totaling not more than 75,000 square feet in PA 20A.

2. PRINCIPAL PERMITTED USES SUBJECT TO ZONING ADMINISTRATOR APPROVAL:

- a. Community facilities including the following uses, and related and similar uses:
 - 1) Intra-community directional signs.
 - 2) Riding, hiking and bicycle trails.
 - 3) Security facilities and structures.
 - 4) Maintenance facilities and structures.
- b. Community service and community service commercial facilities including the following uses, and related similar uses:
 - 1) Fire stations.
 - 2) Public and private nursery schools and day care.
 - 3) Public and private recreation centers and facilities.
 - 4) Visitor/information services/centers.
- c. Communication transmitting, reception or relay facilities.

d. Public parks, except in Planning Areas PA 13A, PA 13B, PA 13C, PA 13D, PA 13E, and PA 13F.

e. Accessory Permitted Uses listed in Section C of this Chapter when located on a separate building site.

C. ACCESSORY PERMITTED USES

Accessory uses and structures are permitted when customarily associated with and subordinate to a Principal Permitted Use on the same building site, per Zoning Code Section 7-9-137 as applicable, including:

1. Garages, carports, and parking structures;
2. Detached accessory structures such as greenhouses, gazebos, cabanas, and storage sheds;
3. Swimming pools, therapy baths, water fountains, and related equipment;
4. Covered patios and decks;
5. Fences and walls;
6. Tennis courts, walkways/trails, greenbelts, and common areas;
7. Signs per Zoning Code Section 7-9-144;
8. Chapels; and
9. Community Information Centers, including sales offices for any and all development within The Planned Community.

D. PROHIBITED USES

1. Camping facilities, including tent camping and recreational vehicle parks.
2. Professional and administrative offices not directly ancillary to and supportive of a permitted use.
3. Industrial and manufacturing facilities.
4. Adult entertainment businesses.
5. Uses not provided by Section B and C of this Chapter shall be prohibited, however it is recognized that certain permitted uses are only defined generally and may require interpretation by the Director, EMA, per Zoning Code Section 7-9-20.

E. SITE DEVELOPMENT STANDARDS

1. Standards applicable to all Tourist Commercial Planning Areas combined:
 - a. Overnight/resort accommodations: A combined total of two thousand one hundred and fifty (2,150) overnight/resort accommodations is permitted. Within Planning Areas PA 13A-13F and PA 14, there shall be a maximum of 2,150 overnight/resort accommodation units. Of this total, (1) no more than 1,800 units may be individually owned; and (2) at least 350 units shall be hotel, motel or other non-individually owned, non-timesharing condominium resort accommodations. Coastal Development Permits for individually owned and timesharing condominium overnight/resort accommodations shall be conditioned to require contracting with a management company or companies to supply rental services to the project (e.g., advertising of units to the general public, taking reservations for the general public, housecleaning, guest check-in, security, etc.).
2. Standards applicable to specific individual Tourist Commercial Planning Areas:

- a. Planning Area PA 13A, PA 13B, PA 13C, PA 13D, PA 13E, and PA 13F (Pelican Hill) shall conform to the LCP Land Use Plan's Tourist Commercial Policies Section I-4-A:
- 1) Overnight/resort accommodations: A total of one thousand nine hundred (1,900) overnight/resort accommodations is permitted in the entire Planning Area PA 13.
 - 2) Casitas shall be counted as follows with respect to the maximum 1,900 permitted overnight/resort visitor accommodations:
 - a) Casitas with one or two bedrooms shall be considered one (1) overnight/resort accommodation; and
 - b) Casitas with 3 or more bedrooms shall be considered two (2) overnight/resort accommodations.
 - 3) Principal permitted uses and accessory uses, including accommodations, resort facilities, and the golf course clubhouse but excepting parking facilities and day use commercial facilities specified in (4) below, shall not exceed a total of 2.66 million square feet. Within this total area, the following limitations shall apply:
 - a) No one of the Planning Areas PA 13A, PA 13B, PA 13C, or PA 13D shall contain more than 60,000 square feet of single, continuous primary ballroom/exhibition space. ("Single, continuous primary ballroom/exhibition space" denotes one large-scale meeting/convention area and does not include the square footage of conference facilities with smaller individual meeting rooms.)
 - b) The total square footage of conference and meeting space, including primary ballroom/ exhibition space and individual meeting rooms, shall not exceed 140,000 square feet in these four Planning Areas.
 - 4) Commercial uses: A maximum of seventy-five thousand (75,000) square feet of total floor area is permitted in addition to that included within hotels and other

accommodations areas. Any day-use retail commercial facilities under this subsection shall be incidental accessory, or directly related to adjacent accommodations, park, and/or recreational visitor activities and shall be identified specifically in any project application involving this use category.

5) Maximum building heights are designated by individual height zones on Exhibit J (see LUP Chapter 4).

6) The following maximum building coverages are expressed as a percentage of each planning area's total gross acreage:

a) The maximum building coverage (except parking structures) within each planning area:

PA 13A: Overall coverage = 40% maximum

PA 13B: Overall coverage = 28% maximum

PA 13C: Overall coverage = 50% maximum

PA 13D: Overall coverage = 50% maximum

PA 13E: Overall coverage = 25% maximum

PA 13F: Overall coverage = 20% maximum

b) The distribution of maximum building coverage by various height categories within planning areas is as follows:

PA 13A: The 40% maximum is distributed as follows:

Structures up to 50 ft. in height = 22%;

Structures up to 65 ft. in height = 10%;

Structures up to 85 ft. in height = 6%; and

Structures up to 105 ft. in height = 2%.

PA 13B: The 28% maximum is distributed as follows:

Structures up to 50 ft. in height = 20%; and

Structures up to 65 ft. in height = 8%.

- PA 13C: The 50% maximum is distributed as follows:
 Structures up to 40 ft. in height = 32%;
 Structures up to 60 ft. in height = 10%; and
 Structures up to 80 ft. in height = 8%.
- PA 13D: The 50% maximum is distributed as follows:
 Structures up to 40 ft. in height = 32%;
 Structures up to 60 ft. in height = 10%; and
 Structures up to 80 ft. in height = 8%.
- PA 13E: The 25% maximum shall all be in structures up to 35 ft. in height (i.e., no further distribution by height).
- PA 13F: The 20% maximum shall all be in structures up to 35 ft. in height (i.e., no further distribution by height).
- 7) Minimum building setbacks from the ultimate right-of-way of Pacific Coast Highway:
- PA 13A: All structures will be a minimum of 300 feet from PCH. Structures in excess of 30 feet in height and up to 85 feet in height will be a minimum of 350 feet from PCH. Structures in excess of 85 feet in height will be a minimum of 550 feet from PCH.
- PA 13B: Structures in excess of 50 feet in height will be a minimum of 1,350 feet from PCH.
- PA 13C/
 PA 13F: Structures in excess of 40 feet in height will be a minimum of 1,600 feet from PCH.
- PA 13D/
 PA 13E: Structures in excess of 40 feet in height will be a minimum of 2,800 feet from PCH.

- 8) Other building setbacks:
- a) From Newport Coast Drive - fifty (50) feet minimum. (Minimum setback for surface parking will be ten (10) feet.)
 - b) From Category A and B ESHA's - one-hundred (100) feet minimum.

9) Landscape screening:

Landscape screening in the form of earth berms, edge planting along Pacific Coast Highway, golf course landscaping, and hotel landscaping will all combine to act as screening to soften building massing as viewed from Pacific Coast Highway.

- 10) Minimum landscaping for each Tourist Commercial site shall be 15% of the net area of the site.

- 11) Grading of the Tourist Commercial sites will create a smooth and gradual transition between new and existing grades.

- 12) Grading of Tourist Commercial sites may be done concurrently with grading for the golf course to balance cut and fill within the resort area and to reduce the total amount of time during which major grading operations will need to be conducted.

b. Planning Area PA 13A shall conform to the LCP Land Use Plan's Tourist Commercial Policies Section I-4-A:

- 1) Overnight/resort accommodations: Eleven hundred (1,100) overnight/resort accommodations maximum, so long as the overall 1,900 overnight/resort accommodations maximum is not exceeded for the entire Planning Area PA 13.
- 2) Day-use retail commercial uses: A maximum of seventy-five thousand (75,000) square feet of gross floor area, in addition to that included within hotels and other accommodations areas, is permitted which is incidental, accessory, or directly related to nearby accommodations and/or recreational visitor activities.

- c. Planning Area PA 13B shall conform to the LCP Land Use Plan's Tourist Commercial Policies Section I-4-A:
- 1) Overnight/resort accommodations: Six hundred (600) overnight/resort accommodations maximum, so long as the overall 1,900 overnight/resort accommodations maximum is not exceeded for the entire Planning Area PA 13.
- d. Planning Area PA 13C shall conform to the LCP Land Use Plan's Tourist Commercial Policies Section I-4-A:
- 1) Overnight/resort accommodations: Seven hundred and fifty (750) overnight/resort accommodations maximum, so long as the overall 1,900 overnight/resort accommodations maximum is not exceeded for the entire Planning Area PA 13.
- e. Planning Area PA 13D shall conform to the LCP Land Use Plan's Tourist Commercial Policies Section I-4-A:
- 1) Overnight/resort accommodations: Six hundred fifty (650) overnight/resort accommodations maximum, so long as the overall 1,900 overnight/resort accommodations maximum is not exceeded for the entire Planning Area PA 13.
- f. Planning Area PA 13E shall conform to the LCP Land Use Plan's Tourist Commercial Policies Section I-4-A:
- 1) Overnight/resort accommodations: Three hundred (300) overnight/resort accommodations maximum, so long as the overall 1,900 overnight/resort accommodations maximum is not exceeded for the entire Planning Area PA 13.
- g. Planning Area PA 13F shall conform to the LCP Land Use Plan's Tourist Commercial Policies Section I-4-A:
- 1) Overnight/resort accommodations: No overnight/resort accommodations are permitted within Planning Area 13F.

h. Planning Area PA 14 (Lower Wishbone) shall conform to the LCP Land Use Plan's Tourist Commercial Policies Section I-4-A:

- 1) Overnight/resort accommodations: Two hundred and fifty (250) overnight/resort accommodations.
- 2) Casitas shall be counted as follows with respect to the maximum 250 permitted overnight/resort accommodations:
 - a) Casitas with one or two bedrooms shall be considered one (1) overnight/resort accommodation; and
 - b) Casitas with three or more bedrooms shall be considered two (2) overnight/resort accommodations.
- 3) Day-Use Commercial uses: A maximum of twenty-five thousand (25,000) square feet of gross floor area is permitted in addition to that included within hotels and other accommodation areas. Any day-use retail commercial facilities under this subsection shall be incidental, accessory, or directly related to the adjacent park, accommodations, and/or recreational visitor activities.
- 4) Principal permitted uses and accessory uses, including overnight/resort accommodations and all directly supporting commercial facilities but excluding parking facilities and the day-use commercial described in (2) above, shall not exceed a total of 300,000 square feet. Within this total area, Planning Area 14 shall not contain more than 18,750 square feet of meeting space.
- 5) Building height: Thirty-five (35) feet maximum, except towers, gables, spires, flag poles, chimneys, mechanical equipment, and architectural features will have a maximum height of forty-seven (47) feet.
- 6) Building site coverage: Fifty (50) percent maximum, excluding parking structures.

- 7) Building setbacks:
- a) From Pacific Coast Highway - one hundred (100) feet minimum.
 - b) Minimum setback for surface parking from Pacific Coast Highway will be ten (10) feet.
- 8) Minimum site landscaping shall be 15% of the net area of the site. To minimize to the extent practicable any views of the hotel parking areas from inland portions of Crystal Cove State Park, landscape screening shall be provided parallel to the perimeter of parking areas in Planning Area 14 which border Muddy Canyon.
- i. Planning Area PA 20A (Laguna Canyon) shall conform to the LCP Land Use Plan's Tourist Commercial Policies Section I-4-A:
- 1) Principal permitted uses and accessory uses shall not exceed a total of 75,000 square feet of floor area directly related to and/or supportive of the nearby park and/or recreational visitor activities and/or public works facilities.
 - 2) Access: Access to the tourist commercial facilities will be directly from Laguna Canyon Road.
 - 3) Building height: One story maximum, except towers, gables, spires, flag poles, chimneys, mechanical equipment, and architectural features will have a maximum height of thirty-five (35) feet.
 - 4) Building Site Coverage: Forty-five (45) percent maximum, excluding parking structures.
 - 5) Building/Parking setbacks:
 - a) Building from Laguna Canyon Road = 50 feet minimum.
 - b) Surface parking from Laguna Canyon Road = 10 feet minimum.

- 6) Prior to, or concurrent with the recordation of the first final development map in PA 20A the landowner shall record an Offer to Dedicate PA 16A and PA 16B. Such offer shall be subject to immediate acceptance by the County of Orange for a period of three (3) years. In the event that the County does not accept the offer during that time period, said offer shall be available for acceptance by the City of Laguna Beach for a period of three (3) years thereafter.

6) Prior to, or concurrent with the recording of the final development map in PA 30A the landowner shall record an Offer to Redeem PA 10A and PA 10B. Such offer shall be subject to immediate acceptance by the County of Orange for a period of three (3) years. In the event that the County does not accept the offer during that time period, said offer shall be available for acceptance by the City of Laguna Beach for a period of three (3) years thereafter.

CHAPTER 6**GOLF COURSE PLANNING AREAS****A. PURPOSE AND INTENT**

The Golf Course Planning Areas of The Newport Coast Planned Community are established to provide for the development and maintenance of primarily golf courses, related commercial and noncommercial facilities, and accessory uses and structures in proximity to destination resort and related tourist/recreational visitor-serving commercial facilities. These planning areas permit necessary roads, public works, and infrastructure. These Golf Course Planning Area Regulations are intended to implement the LCP Land Use Plan's Golf Course Policies Section I-4-B subject to the requirements of the LCP Land Use Plan's Policies Chapter 3 and 4.

B. PRINCIPAL PERMITTED USES

The following principal permitted uses are permitted in all Planning Areas designated for Golf Course use subject to the approval of a Coastal Development Permit as provided in Chapter 10:

1. PRINCIPAL PERMITTED USES SUBJECT TO PLANNING COMMISSION APPROVAL:

- a. Golf courses and clubhouses.
- b. Driving ranges and putting greens.
- c. Commercial and noncommercial recreation uses and facilities such as tennis courts, racquetball courts, health clubs, etc.
- d. Clubhouse facilities, including restaurants, cocktail lounges, banquet rooms, meeting facilities, and similar uses related to a permitted recreation use or complex.
- e. Community facilities and community service facilities.

2. PRINCIPAL PERMITTED USES SUBJECT TO ZONING ADMINISTRATOR APPROVAL:

- a. Lakes, ponds, and associated drainage facilities.
- b. Public works, infrastructure, and road improvements.
- c. Communication transmitting, reception or relay facilities.
- d. Accessory Permitted Uses listed in Section C of this Chapter when located on a separate building site.

C. ACCESSORY PERMITTED USES

Accessory uses and structures are permitted when customarily associated with and subordinate to a Principal Permitted Use on the same building site, per Zoning Code Section 7-9-137 as applicable, including:

1. Information center, shops, and commercial concessions related to golf course use and accessory to the clubhouse operation;
2. Maintenance facilities and structures, caretaker quarters, garages, carports, and storage sheds;
3. Detached accessory structures such as greenhouses, gazebos, and cabanas;
4. Swimming pools, saunas, therapy baths, water fountains, and related equipment;
5. Covered patios and decks;
6. Fences and walls;
7. Walkways/trails, greenbelts, and common areas; and

8. Signs per Zoning Code Section 7-9-144.

D. PROHIBITED USES

1. Camping facilities including tent and/or RV campgrounds.
2. Professional and administrative offices not directly ancillary to and supportive of a permitted use.
3. Industrial and manufacturing facilities.
4. Uses not provided by Section B and C of this Chapter shall be prohibited, however it is recognized that certain permitted uses are only defined generally and may require interpretation by the Director, EMA, per Zoning Code Section 7-9-20.

E. SITE DEVELOPMENT STANDARDS

1. Building height: Forty (40) feet maximum.
2. Setback from streets: Twenty (20) feet minimum.
3. Clubhouse building site coverage: Fifty (50) percent maximum.
4. Off-street parking: Shall be provided per Chapter 9 of this IAP.
5. Screening: Walls and fences over six (6) feet in height shall be installed in accordance with the following limitations, unless otherwise provided for by an approved Site Plan.
 - a. Hazard fences for golf courses may be installed where necessary to protect buildings, vehicles, and persons (no height limitation).

- b. Non-opaque fences shall be a minimum of twenty (20) feet from the ultimate right-of-way of any street or highway.
6. Grading and Erosion Control: Grading and Erosion Control Plans shall conform with the Land Use Plan's Resource Conservation and Management Policies Sections I-3-J, I-3-K, I-3-L, and I-3-M.
 7. Lights: All lights shall be designed so that all rays are aimed at the site.
 8. Habitat irrigation shall conform with the Riparian Habitat Creation Program (RHCP) of the Land Use Plan's Golf Course Policies Section I-4-B-5 and the following criteria shall be applied:
 - a. The RHCP shall include a drawing showing the relationship of riparian habitat areas, ponds, transition areas, and adjacent golf course features. Areas shall be designated as primarily habitat (i.e., riparian habitat areas), multi-purpose (i.e., ponds and transition areas), and primarily recreational (i.e., golf course features).
 - b. For riparian habitat areas, the RHCP shall show how topography, water supply and drainage patterns, and soil type and conditions will be made suitable for the growth, establishment, and persistence of the planted vegetation.
 - c. Planting plans prepared for the RHCP shall address methods to propagate riparian vegetation, responding to the following priorities as feasible: a) seed, cuttings, and/or transplants of existing plants salvaged/collected on-site; b) seed or cuttings from other sources. Transplants of existing plants may be used only to the degree that the benefits outweigh the increased probability of failure due to shock, root stress, etc. associated with transplanting.
 - d. The RHCP shall address management of exotic species as follows. A list of highly invasive and undesirable plants to be removed upon detection (e.g., pampas grass) will be prepared, including sensitive control methods which do not compromise riparian plantings.

Criteria for determining when other exotic plants (e.g., wild oats, rye grass) compete unduly with planted vegetation will be included, also including sensitive control methods.

- e. The RHCP shall address topsoil management, giving first priority to use of native topsoil provided it is free of significant weed seed reservoirs, salt concentrations, and similar detrimental factors; and giving second priority to other soil material placed by grading.
- f. The RHCP shall address treatment of transitional areas (i.e., "rough") between golf play areas and habitat areas, to include their function as buffers. Plans for multi-purpose features, ponds in particular, will show which edges are to be intensively managed for golf course/aesthetic considerations, which edges are to be managed primarily for habitat purposes, and how ponds will be managed to accommodate both golf course/aesthetic and habitat interests.
- g. The RHCP shall include measures addressing maintenance of golf course features and habitat areas to minimize conflicts between maintenance and use of the golf course and the riparian habitat.
- h. The RHCP shall provide for monitoring of the success of the riparian habitat creation based upon stated habitat objectives.
- i. As a condition of approval, the RHCP shall be reviewed by the California Department of Fish and Game and, if appropriate, approved through a Streambed Alteration Agreement pursuant to Section 1600 et seq. of the State Fish and Game Code.

Criteria for determining when exotic plants (e.g., wild oats, eye grass) compete with planted vegetation will be included, also including sensitive control methods.

2. The RHCIP shall address topsoil management, giving first priority to use of native topsoil provided it is free of significant weed seed reservoirs, salt concentrations, and similar detrimental factors; and giving second priority to other soil material placed by grading.

3. The RHCIP shall address treatment of transitional areas (i.e., "roughs") between golf play areas and habitat areas to include their function as buffers. Plans for multi-purpose features, ponds in particular, will show which edges are to be intensively managed for golf course/aesthetic considerations, which edges are to be managed primarily for habitat purposes, and how ponds will be managed to accommodate both golf course/aesthetic and habitat interests.

4. The RHCIP shall include measures addressing maintenance of golf course features and habitat areas to minimize conflicts between maintenance and use of the golf course and the riparian habitat.

5. The RHCIP shall provide for monitoring of the success of the riparian habitat creation based upon stated habitat objectives.

6. As a condition of approval, the RHCIP shall be reviewed by the California Department of Fish and Game and, if appropriate, approved through a Streambed Alteration Agreement pursuant to Section 1600 et seq. of the State Fish and Game Code.

7. Recreation Planning Areas

CHAPTER 7**RECREATION PLANNING AREAS****A. PURPOSE AND INTENT**

Certain Recreation Planning Areas (i.e., PA 12F, PA 12G, PA 12J PA 17, PA 18, PA 19, PA 20B, and PA 20C) of The Newport Coast Planned Community are established to provide for the public ownership, development, and maintenance of primarily regional recreational activities and facilities as well as public infrastructure facilities which will afford the greatest public access and benefit without adversely altering the sites.

Certain other Recreation Planning Areas (i.e., PA 11A, PA 11B, PA 12A, PA 12B, PA 12C, PA 12D, PA 12E, PA 12F, PA 12H, and PA 12I) are established to serve open space/recreation uses as provided for in The Newport Coast LUP.

The Recreation Use Regulations are intended to implement the LCP Land Use Plan's Recreation/Public Access Policies Section I-4-C subject to the requirements of the LCP Land Use Plan's Policies in Chapter 3 and 4.

B. PRINCIPAL PERMITTED USES

Consistent with the policies of LUP, Section I-3-C, the following principal permitted uses are permitted in Planning Areas designated for Recreation use subject to the approval of a Coastal Development Permit by the Zoning Administrator as provided in Chapter 10. Such uses may be operated by a limited commercial venture with the purpose of serving the recreational needs of park visitors and/or improving public recreation services whether financially through lease or other payments to a public agency or functionally through the delivery of a permitted recreational use that otherwise would not be available to the public.

1. PLANNING AREA PA 18 (EMERALD CANYON):

- a. Riding and hiking trails.
- b. Picnic areas.
- c. Viewpoints, non-commercial rest stops, and other passive recreation facilities.
- d. Regional Park concessions associated with park use consistent with LUP Policies Section I-3-C.

2. PLANNING AREA PA 19 (EMERALD RIDGE):

- a. Parking areas.
- b. Camping.
- c. Youth hostels.
- d. Non-commercial staging areas.
- e. Picnic areas.
- f. Equestrian centers.
- g. Regional park concessions associated with park use consistent with LCP Policies Section I-3-C.
- h. Riding and hiking trails.

3. PLANNING AREA PA 20B (LAGUNA CANYON):

- a. Parking areas.
- b. Riding and hiking trail staging areas.
- c. Public utilities within existing easements.
- d. Existing agricultural operations.
- e. Existing educational institutions.
- f. Cultural facilities as temporary facilities in support of periodic cultural events.
- g. Public parks.
- h. Maintenance of public facilities/roads.
- i. Existing municipal yards.

4. PLANNING AREAS PA 12G AND PA 20C:

- a. Commercial recreation related to park use.
- b. Specialty retail shops related to park use.
- c. Restaurants and food sales serving visitors to the adjacent regional and state parks.
- d. Museums, art galleries, outdoor amphitheaters, and other cultural/educational uses and facilities.
- e. Arboretums and horticultural gardens.
- f. Staging areas for campers, riders, hikers, and other visitors to the adjacent Irvine Coast Wilderness Regional Park and Crystal Cove State Park.
- g. Regional Park support facilities such as, but not limited to, ranger headquarters, regional park parking facilities, and restroom facilities.

5. PLANNING AREA PA 17 (CRYSTAL COVE STATE PARK):

Crystal Cove State Park's "Public Works Plan" has already been certified by the Coastal Commission for Recreation Planning Area PA 17 and, accordingly, is not part of this LCP.

6. PLANNING AREAS PA 11A, PA 12A, PA 12E, PA 12H AND PA 12I:

- a. Local parks.
- b. Riding and hiking trails.
- c. Bikeways.
- d. Utilities, drainage, and water supply facilities as provided for in Chapters 3 and 4 of the LUP.
- e. Fuel modification and fire protection facilities and accessways related to park protection.

7. PLANNING AREAS PA 11B, PA 12B, AND PA 12D:

- a. Passive recreation uses;
- b. Open Space (natural and modified for fire protection pursuant to LUP Policy Section I-3-M, Development/Open Space Edges Policies);

- c. Passive preservation areas for archaeological and paleontological sites and identified ESHA's;
- d. Open space within lot lines from adjoining residential areas where the land is owned and maintained by adjacent homeowners or homeowners associations (not public agencies or districts);
- e. Public works, roads, and infrastructure necessary for other permitted uses; and
- f. Hiking trails.

8. PLANNING AREA 12C:

- a. Parking areas;
- b. Riding and hiking trail staging areas;
- c. Picnic areas, parks, trails, greenbelts and common areas;
- d. Equestrian and community centers;
- e. Swimming pools, tennis courts, ball fields and detached accessory structures and related equipment;
- f. Fences and walls;
- g. Roads, utilities, drainage and water supply facilities; and
- h. Communication transmitting, reception or relay facilities.

9. PLANNING AREA 12F:

- a. Schools;
- b. Parking areas;
- c. Swimming pools, tennis courts, ball fields and detached accessory structures and related equipment;
- d. Fences and walls;
- e. Roads, utilities, drainage, sewer and water supply facilities; and
- f. Communication transmitting, reception or relay facilities.

10. PLANNING AREA 12J:

- a. Roads, utilities, drainage, sewer, water storage and supply facilities;
- b. Detached maintenance and accessory structures;
- c. Parking areas;
- d. Fences and walls;
- e. Communication transmitting, reception or relay facilities; and
- f. Fuel modification and fire prevention facilities and access ways.

C. OTHER PERMITTED USES IN PA 18, PA 19, PA 20B, AND PA 20C SUBJECT TO COASTAL COMMISSION APPELLATE JURISDICTION OVER "CD" PERMITS

1. New utility development.
2. New roads or expansions. Any widening or relocation of Laguna Canyon Road shall conform with IAP Special Provision Subsection II-3-B-27.

D. ACCESSORY USES PERMITTED

Accessory uses and structures are permitted when customarily associated with and subordinate to a Principal Permitted Use on the same building site per Zoning Code Section 7-9-137.

E. PROHIBITED USES

1. Recreation vehicle (RV) Parks.
2. Industrial and manufacturing facilities.
3. Sand and gravel extraction.
4. The fencing of homeowner lots and lot lines extending into Planning Areas PA 11B, PA 12B, and PA 12C.

5. Uses not provided by Section B through D of this Chapter shall be prohibited, however it is recognized that certain permitted uses are only defined generally and may require interpretation by the Director, EMA, per Zoning Code Section 7-9-20.

F. SITE DEVELOPMENT STANDARDS

1. Building site area: No minimum.
2. Building site width and depth: No minimum.
3. Building setbacks: All buildings shall be set back from property lines a distance at least equal to the height of the building or structure, and not less than thirty (30) feet from any adjacent Residential Planning Area.
4. Building site coverage: Not more than one (1) percent of the total lands in this land use category may be covered by buildings except as defined for PA 11A, PA 12A, PA 12E, PA 12I, PA 18, PA 19, PA 20B, and PA 21D. A maximum of twelve (12) percent of the total land area in PA 12B, PA 12C, PA 12G and PA 12H may be developed with structures, pavement or other impervious materials.
5. Building height limit: Fifteen (15) feet for PA 12G; eighteen (18) feet for PA 11A, PA 11B, PA 12A, PA 12B, PA 12D, PA 12E, PA 18, PA 19, and PA 20B; and twenty-five (25) feet for PA 20C; and thirty-five (35) feet for PA 12C, PA 12F and PA 12 .
6. Off-street parking: Shall be provided per Chapter 9 of this IAP.
7. Screening: Due to the recreational open space character of many of the permitted uses, the following screening standards may not be appropriate in all cases, and Alternative Development Standards may be established by an approved Coastal Development Permit. Generally, walls and fences may be installed in accordance with the following limitations:

- a. Natural wood, concrete, stone, masonry, and/or wrought iron non-opaque fences may be installed, provided they are consistent with the Purpose and Intent of this Chapter, and are set back a minimum of twenty (20) feet from the ultimate right-of-way line of any street or highway.
- b. Masonry or solid wood fences shall be shielded from view from any street or highway by landscaping and/or berms or other topographic features, and shall be set back a minimum of fifty (50) feet from the ultimate right-of-way line of any street or highway.
- c. Parking areas adjacent to public or private streets or highways shall generally be screened from view by earthen berms and/or landscaping.

- a. Natural wood, concrete, stone, masonry, and/or wrought iron non-opaque fences may be installed, provided they are consistent with the purpose and intent of this Chapter, and are set back a minimum of twenty (20) feet from the ultimate right-of-way line of any street or highway.
- b. Masonry or solid wood fences shall be shielded from view from any street or highway by landscaping and/or berms or other topographic features, and shall be set back a minimum of fifty (50) feet from the ultimate right-of-way line of any street or highway.
- c. Parking areas adjacent to public or private streets or highways shall generally be screened from view by earthen berms and/or landscaping.

8. Conservation Planning Areas

CHAPTER 8**CONSERVATION PLANNING AREAS****A. PURPOSE AND INTENT**

The Conservation Planning Areas of The Newport Coast Planned Community are established to provide for the resource preservation, enhancement, limited development, and maintenance of largely natural and undeveloped lands identified for resource conservation, where the natural resources are to be preserved and enhanced after acquisition by a public agency. Most Conservation lands are currently under private ownership and will be transferred in increments to a public agency over a period of time. Prior to transfer, the private landowner will be responsible for the maintenance and management of these lands. These Conservation Planning Area regulations are intended to implement the LCP Land Use Plan's Conservation Area Policies Section I-3-A subject to the requirements of the LCP Land Use Plan's Policies in Chapters 3 and 4.

B. PRINCIPAL PERMITTED USES

The following principal permitted uses are permitted in Planning Areas PA 16A, PA 16B, PA 21A, PA 21B, PA 21C, and PA 21D designated for Conservation Use subject to the approval of a Coastal Development Permit by the Zoning Administrator as provided in Chapter 10:

1. Passive recreation uses.
2. Viewpoints and overlook areas.
3. Riding and hiking trails.
4. Scientific study areas.
5. Maintenance of existing public improvements/facilities.

6. Uses permitted only within three hundred and fifty (350) feet of Laguna Canyon Road, and/or on land of less than thirty (30) percent slope:
 - a. Riding and hiking trailheads;
 - b. Riding and hiking trail staging areas;
 - c. Maintenance of existing utilities;
 - d. Maintenance of existing flood, drainage, and erosion control facilities; and
 - e. Road improvements, expansions, and maintenance.
7. Any widening or relocation of Laguna Canyon Road shall conform with IAP Special Provision Subsection II-3-B-27.

C. ACCESSORY PERMITTED USES

Accessory uses and structures are permitted when customarily associated with and subordinate to a Principal Permitted Use on the same building site, per Zoning Code Section 7-9-137.

D. PROHIBITED USES

1. Primary residential structures.
2. Commercial uses.
3. Industrial and manufacturing facilities.
4. Sand and gravel extraction.
5. Uses not provided by Section B and C of this Chapter shall be prohibited, however it is recognized that certain permitted uses are only defined generally and may require interpretation by the Director, EMA, per Zoning Code Section 7-9-20.

E. INTERIM CONSERVATION MANAGEMENT

The following shall apply to any private-sector landowner prior to the transfer of Conservation areas to public ownership. All improvements shall be consistent with the LCP Land Use Plan's Interim Conservation Management Policies Section I-3-B:

1. The landowner may continue existing agricultural uses, including cattle grazing and may construct and maintain any fencing, firebreaks, fuel modification zones, water pipes, and cattle-watering facilities, and maintain access roads necessary for the continued use and protection of the property, and for facilities approved by the County of Orange for public health, safety, welfare, and recreation purposes consistent with this chapter.
2. New fences will be designed so that wildlife, except large mammals such as deer, can pass through.
3. No alteration to existing stream courses or landforms in Emerald Canyon will occur except as necessary to provide fire protection.
4. No excavations of archaeological and paleontological sites will be permitted except as required by public safety and/or utilities facilities and in accordance with the policies set forth in Sections I-3-G and I-3-H.
5. Landform alterations are allowed in Conservation areas to the extent required to accommodate realignment, improvement, and/or widening of Laguna Canyon Road and associated improvements and shall conform with the requirements of IAP Section II-3-B-27 for any such project.
6. No agricultural practice shall aggravate known or suspected land management problems such as the spread of non-native plants, soil erosion, or the deterioration of sensitive environmental habitats.

F. PARK DEVELOPMENT STANDARDS

The following standards shall apply to those areas designated for Conservation uses after acquisition by a public agency:

1. Wildlife habitats shall be preserved by controlling human access to Emerald Canyon.
2. Key areas of chaparral and coastal sage shall be protected from human intrusion.
3. Stream courses in Emerald Canyon shall be retained in a natural state or enhanced.
4. Significant riparian areas shall be preserved as sources of shelter and water for wildlife.
5. Improvements shall be compatible with the natural environment and shall not damage landforms, vegetation, or wildlife to any significant degree.
6. All archaeological sites and paleontological sites shall be preserved.
7. All buffer areas necessary for the protection of habitat are located within the Conservation category.

9. Off-Street Parking
Regulations

CHAPTER 9

OFF-STREET PARKING REGULATIONS

A. PURPOSE AND INTENT

The purpose of these regulations is to provide for the off-street parking of motor vehicles within The Newport Coast Planned Community. The parking facilities required by this Chapter are assumed to be the minimum which will be required by the various land use categories. It is intended that these regulations will result in properly designed parking facilities of sufficient capacity to reduce traffic congestion, provide safe and convenient facilities for motorists and pedestrians, and generally provide for the parking of motor vehicles at locations other than on streets.

B. GENERAL REQUIREMENTS

Except as otherwise specified herein, off-street parking for The Newport Coast Planned Community shall be in accordance with Section 7-9-145, Off-Street Parking Regulations, of the County of Orange Zoning Code, which is incorporated by reference as a part of this Chapter.

1. **Location of Off-Street Parking:** Required parking spaces and garages shall be located conveniently close to the use or uses they serve.
2. **Common Area Parking:** Common area parking may be approved by a Coastal Development Permit or Site Plan.
3. **Joint Use Parking:** Parking reductions from the aggregate total requirement of different uses within a hotel, motel, or similar accommodations development, or due to shared parking or joint use, shall be allowed in conformance with the standards outlined herein.

C. STANDARDS FOR INDIVIDUAL PRINCIPAL USES

The following standards delineate the minimum facilities required for three individual principal uses:

- | | |
|---|---|
| 1. Hotels, motels, and similar accommodations including accessory/ancillary uses: | One (1) parking stall per guest unit. |
| 2. Restaurants: | Ten (10) parking stalls minimum; or one (1) stall for each 100 s.f. of gross floor area up to 4,000 s.f., plus one (1) for each 80 s.f. of gross area over 4,000 s.f. |
| 3. Retail and service commercial stores: | One (1) parking stall per 200 s.f. |

Parking requirements for mixed-use developments such as a destination resort are separately addressed in Section D of this Chapter.

D. JOINT-USE OR SHARED PARKING

A reduction in "required" parking for each principal use will be permitted for either joint-use or shared parking upon the approval of a Detail Parking Plan by the Director, EMA. The request for a parking reduction due to joint use or shared parking shall be accompanied by findings in the Detail Parking Plan which determine that:

1. Such modifications will have no negative impact on public access to the beach and parking for public recreational uses; and
2. The permit approval shall be conditioned upon the recording with the County Recorder of an agreement, executed by all parties concerned in the shared parking arrangement, assuring the continued availability of the required number of spaces.

E. EXCEPTIONS AND/OR MODIFICATIONS TO OFF-STREET PARKING REQUIREMENTS

The provisions of this Chapter and Section 7-9-145 of the County of Orange Zoning Code are intended to meet the minimum design needs for off-street parking under most conditions. Where, because of the nature of the use involved or other relevant circumstance, the requirements of this Chapter are considered to be excessive, an exception and/or modification to these provisions and those of Section 7-9-145 of the County of Orange Zoning Code may be approved in accordance with the following procedure, provided such exception and/or modification is consistent with the purpose and intent of this Chapter:

1. Any property owner, his authorized agent, or a public agency may apply for an exception to, or modification of, the off-street parking requirements set forth in this Chapter and/or Section 7-9-145 of the County of Orange Zoning Code.
2. Exceptions to, or modifications of, the off-street parking regulations shall be permitted subject to the approval of a Use Permit or a Coastal Development Permit.
3. Coastal Development Permits or Use Permits which include a request for an exception to, or modification of, off-street parking requirements shall be processed in accordance with the provisions of Chapter 10 of this IAP.

E. EXCEPTIONS AND/OR MODIFICATIONS TO OFF-STREET PARKING REQUIREMENTS

The provisions of this Chapter and Section 7-9-145 of the County of Orange Zoning Code are intended to meet the minimum design needs for off-street parking under most conditions. Where, because of the nature of the use involved or other relevant circumstances, the requirements of this Chapter are considered to be excessive, an exception and/or modification to these provisions and those of Section 7-9-145 of the County of Orange Zoning Code may be approved in accordance with the following procedure, provided such exception and/or modification is consistent with the purpose and intent of this Chapter:

1. Any property owner, his authorized agent, or a public agency may apply for an exception to, or modification of, the off-street parking requirements set forth in this Chapter and/or Section 7-9-145 of the County of Orange Zoning Code.
2. Exceptions to, or modifications of, the off-street parking regulations shall be permitted subject to the approval of a Use Permit or a Coastal Development Permit.
3. Coastal Development Permits or Use Permits which include a request for an exception to, or modification of, off-street parking requirements shall be processed in accordance with the provisions of Chapter 10 of the IAP.

CHAPTER 10

DISCRETIONARY PERMITS AND PROCEDURES

A. GENERAL REQUIREMENTS

Section 7-9-118, "Coastal Development" (CD) District, and Section 7-9-150, "Discretionary Permits and Procedures", of the County of Orange Zoning Code are incorporated by reference into this Implementing Actions Program (IAP). In the event of conflicting provisions between this Chapter and Sections of the County of Orange Zoning Code, this Chapter shall take precedence. In the event of conflicting provisions between Section 7-9-118 and Section 7-9-150 of the County of Orange Zoning Code, the requirements of the CD District shall take precedence.

1. PRINCIPAL PERMITTED USES:

Land Uses listed in this IAP as principal permitted uses, are considered to be within the category of "principal permitted use" under the County of Orange Zoning Code Section 7-9-118, the California Coastal Act of 1976, in general, and Public Resources Code Section 30603 (a) (4), in particular.

2. COASTAL DEVELOPMENT PERMITS:

A Coastal Development Permit (CDP) shall be processed in compliance with the CD "Coastal Development" District Regulations, Section 7-9-118, of the County Zoning Code.

A CDP may be processed as a large-scale Master Coastal Development Permit. Other CDP's may be approved by either the Zoning Administrator or Planning Commission as specified in each land use regulations chapter.

A CDP may be approved which establishes alternative development standards in conformance with Subsection 4 of this Section.

3. APPLICATIONS:

This Section applies to this Newport Coast Implementing Actions Program and references Sections 7-9-118 of the County Zoning Code with exceptions as noted herein:

a. Tourist Commercial Use Applications -- Applications for Coastal Development Permits shall contain the following information:

1) Large-Scale Plan:

- a) Location, acreage, and type of land use for each building.
- b) Topography: existing and proposed (i.e., Concept Grading Plan).
- c) General public street/corridor layout and width.
- d) Existing structures and development on adjacent parcels, to a minimum of two hundred (200) feet from the Planning Area.
- e) Location of riding and hiking trails.
- f) Location and treatment of significant cultural/scientific resources.
- g) Location of significant vegetation and an indication of the resources to be altered and the resources to be preserved.
- h) Location and treatment of scenic highways, if applicable.
- i) Location of extensions of off-site roads or utilities through a Planning Area to serve adjacent areas.

2) Large-Scale Elevations -- of all primary structures including, but not limited to the following:

- a) Predominant exterior materials;
- b) Predominant exterior colors; and
- c) Building heights.

3) A list of any proposed Alternative Development Standards.

b. Other Land Use Applications -- Applications for Coastal Development Permits, including a Master Coastal Development Permit, shall contain the following information:

- 1) Large-Scale Plan:
 - a) Location, acreage, and type of land use for each building site.
 - b) Range of dwelling units to be developed on each building site.
 - c) General public street/corridor layout and width.
 - d) Location and acreage of landscape, open space and recreation areas.
 - e) Park location and acreage, if applicable.
 - f) School location and acreage, if applicable.
 - g) Location, acreage, and land use of all non-residential areas.
 - h) Topography: existing and proposed (i.e., Concept Grading Plan).
 - i) Existing structures and development on adjacent parcels, to a minimum of two hundred (200) feet from the Planning Area.
 - j) Concept Drainage Plan.
 - k) Location of riding and hiking trails.
 - l) Location and treatment of significant cultural/scientific resources.
 - m) Location of significant vegetation and an indication of the resources to be altered and the resources to be preserved.
 - n) Location and treatment of scenic highways, if applicable.
 - o) Location of extensions of off-site roads or utilities through a Planning Area to serve adjacent areas.

- 2) A list of any proposed Alternative Development Standards.

- 3) The "Master Drainage and Runoff Management Plan", if required by Subsection II-3-B-11.

4. **ALTERNATIVE DEVELOPMENT STANDARDS:**

With approval of a CDP, alternative development standards may be established without an LCP amendment where the standards pertain to: setbacks to residential streets; nonresidential highways or local streets; rear and side yard setbacks for development not bordering an open space or recreation area; building height (except for Planning Area PA 6) in areas not visible from Pacific Coast Highway; area per unit for residential inland of Pacific Coast Highway; walls and fences; landscaping other than along Pacific Coast Highway; signage; lighting; loading, trash, and storage areas not visible from Pacific Coast Highway; vehicular driveways and sidewalks; outdoor storage areas; and/or modifications for off-street parking requirements in areas inland of Pacific Coast Highway. Alternative development standards other than those specified above will require an LCP amendment.

A CDP proposing to establish alternative development standards shall require a public hearing, with public notification, before the Planning Commission per Zoning Code Section 7-9-150.3(c) as adopted by the County at the time of Coastal Commission Certification of this LCP.

When a Coastal Development Permit proposes to establish an alternative development standards, the burden of proof shall be on the project proponent. The alternative development standards may be approved when it is found that they will result in an equivalent or better project in terms of minimizing adverse impacts and enhancing public benefits to the immediate and surrounding community.

B. **SITE PLANS/SITE DEVELOPMENT PERMITS**

1. **SITE PLAN/SITE DEVELOPMENT PERMIT PROCESS:**

A Site Plan may be required by the Planning Commission or Zoning Administrator for certain development projects in addition to a CDP, and shall be processed in compliance with Zoning Code Section 7-9-150.3(d) unless the Director, EMA, determines, on a case-by-case basis, that the public interest would be better served by a public hearing before the Planning Commission. In such cases, the Site Plan shall be processed per Section 7-9-150.3(c).

Site Plans shall contain all the following data when applicable to the project proposal:

a. **Plot Plans** -- drawn to scale, fully dimensioned and easily readable, containing the following:

- 1) Title block (applicant's name and date drawn).
- 2) Scale and north arrow.
- 3) Property lines or building sites, dimensioned.
- 4) Existing use of property.
- 5) Location, acreage, and proposed type of land use for each building.
- 6) Buildings; existing and proposed use, location and size.
- 7) Number of dwelling units to be developed on each building site.
- 8) Streets/corridor; location and width.
- 9) Easements; location, purpose and width.
- 10) Access; existing and proposed.
- 11) Parking areas.
- 12) Signs; location, height, dimensions, and copy if available.
- 13) Fencing (walls); type, location and height.
- 14) Location, acreage, and ownership of landscape, natural open space and recreation areas.
- 15) Landscape and screening areas.
- 16) Topography, existing and proposed (i.e., Concept Grading Plan).
- 17) Existing structures on abutting properties, location, height and uses.
- 18) Location, width, and treatment of riding and hiking trails.
- 19) Location and acreage of transit terminal.
- 20) Location and treatment of cultural/scientific resources.
- 21) Location of significant vegetation and an indication of the resources to be altered and the resources to be reserved.
- 22) Location and treatment of scenic highways.
- 23) Information required by Chapter 3, General Provisions and Regulations.
- 24) A list of all relevant programs, policies, and guidelines contained in the General Plan and LUP, together with a description of how they are being implemented through the Site Plan.

25) Any additional background and supporting information as the Director, EMA, deems necessary.

b. **Elevations** -- of all structures (including walls and signs) including, but not limited to, the following:

- 1) All exterior materials;
- 2) All exterior colors;
- 3) Building heights; and
- 4) If the Site Plan is for a residential development, typical elevations shall be provided.

c. **Preliminary Landscape Plans** -- including the general location of all plant materials, by common and botanical names.

CHAPTER 11
DEVELOPMENT MAP AND STATISTICAL TABLE
REGULATIONS AND PROCEDURES

A. PURPOSE AND INTENT

The purpose of this Chapter is to provide regulations and procedures for Planning Commission revisions to the Planned Community Development Map and the Planned Community Statistical Table.

B. PLANNED COMMUNITY DEVELOPMENT MAP

The Planned Community (PC) Development Map (See Exhibit W) covers all the territory included within the Planned Community Zoning Map. The PC Development Map identifies Planning Areas and corresponding uses contained in the LCP Land Use Plan, along with other planning information.

The acreages in the Statistical Table on the PC Development Map may vary without requiring an amendment to the LCP Land Use Plan provided that the variation is consistent with the total acreage and boundaries of Development and Open Space shown on the Planned Community (PC) Statistical Summary and does not result in development occurring within the proposed Irvine Coast Regional Park dedication areas.

C. PLANNED COMMUNITY STATISTICAL TABLE

The Planned Community (PC) Statistical Table contains the statistical breakdown for each of the residential and nonresidential Planning Areas shown on the Planned Community Development Map.

The residential density categories on the PC Statistical Table, together with the nonresidential land use categories, shall coincide with the land use categories indicated in the LCP Land Use Plan, the PC Zoning Map, and the PC Development Map.

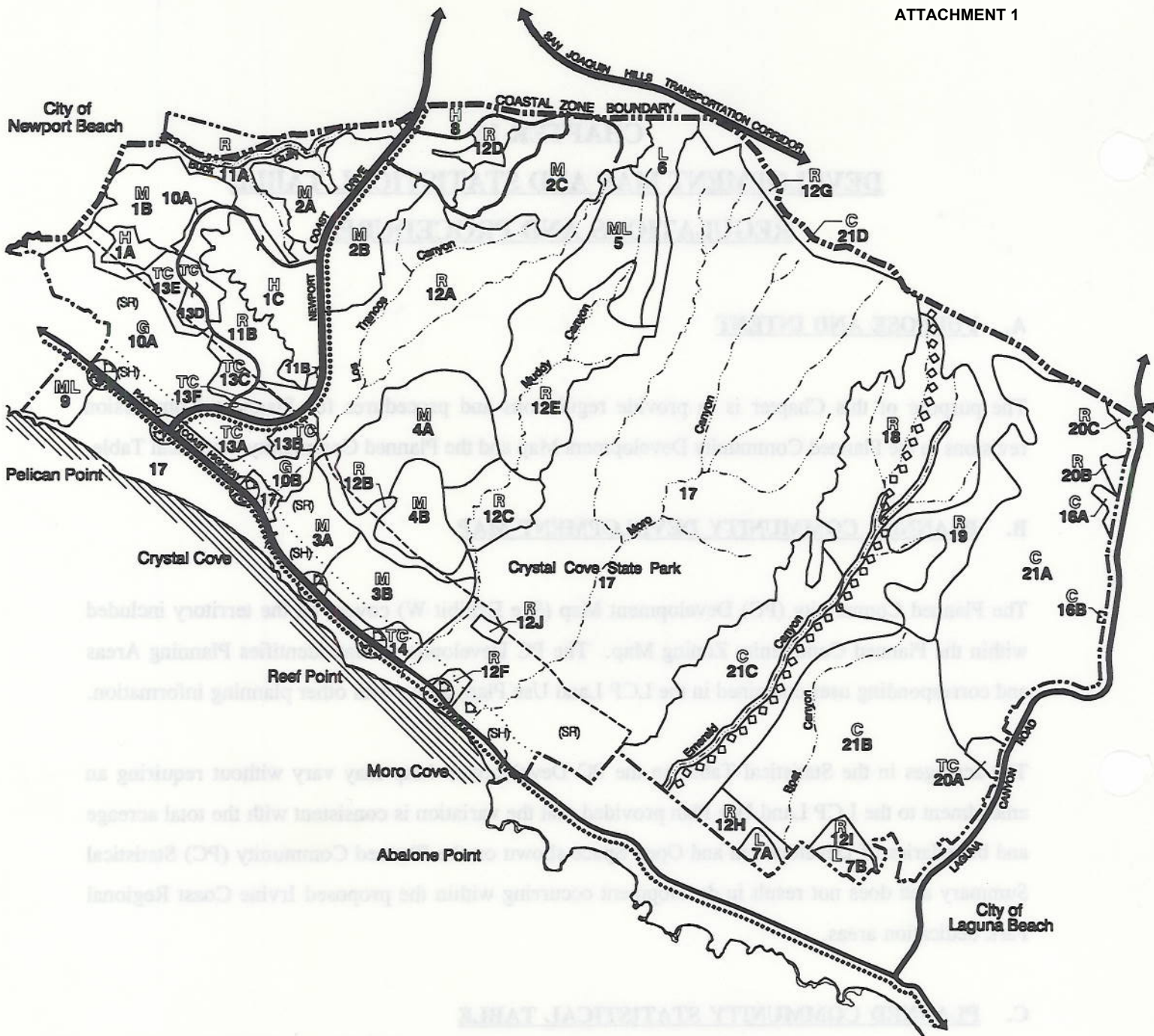

PLANNED COMMUNITY DEVELOPMENT MAP - Second Amendment

The Newport Coast Local Coastal Program

Exhibit W

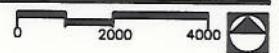

December 3, 1998

LEGEND

COASTAL ZONE BOUNDARY	GOLF COURSE	MAJOR ARTERIAL
PLANNED COMMUNITY BOUNDARY	TOURIST COMMERCIAL	PRIMARY ARTERIAL
PLANNING AREA BOUNDARY	FLOOD PLAIN 2	COLLECTOR
PLANNING AREA	FLOOD PLAIN 3	CLASS II REGIONAL BIKE TRAIL
LOCAL ROAD CONNECTIONS TO P.C.H.	SCENIC HIGHWAY DIST.	REGIONAL RIDING/HIKING TRAIL
LOW DENSITY RESIDENTIAL (0-2)	SIGN RESTRICTION DIST.	SIGNALIZED INTERSECTION
MED-LOW DENSITY RESIDENTIAL (2-3.5)		
MEDIUM DENSITY RESIDENTIAL (3.5-6.5)		
HIGH DENSITY RESIDENTIAL (6.5-18)		



**EXHIBIT X
SECOND AMENDMENT
PLANNED COMMUNITY STATISTICAL TABLE
Newport Coast Local Coastal Program**

LAND USE CATEGORY/CODE	PLANNING AREA	GROSS ACRES NON-COMMERCIAL	GROSS ACRES COMMERCIAL	ESTIMATED(1) DWELLING UNITS/ACCOMMODATIONS	MAXIMUM(2) DWELLING UNITS/ACCOMMODATIONS	Status as of February 12, 1996		
						DWELLING UNITS ON APPROVED SUBDIVISIONS		BUILDING PERMITS ISSUED OR UNITS UNDER CONSTRUCTION
						Tentative Maps	Final Maps	
RESIDENTIAL:								
High/H	1A	25.5	-	29	150	29	29	0
Medium/M	1B	133.7	-	117	140	117	117	52
High/H	1C	184.9	(3)	247	970	247	0	0
Medium/M	2A	109.1	(3)	184	380	184	111	34
Medium/M	2B	204.0	(3)	488	530	488	396	331
Medium/M	2C	258.9	-	490	905	490	0	0
Medium/M	3A	98.0	(3)	265	470	40	0	0
Medium/M	3B	148.0	(3)	226	465	45	0	0
Medium/M	4A	239.0	-	135	784	0	0	0
Medium/M	4B	105.5	-	75	507	0	0	0
Medium-Low/ML	5	150.0	-	95	300	0	0	0
Low/L	6	80.0	-	75	75	53	0	0
Low/L	7A	25.0	-	2	18	0	0	0
Low/L	7B	25.0	-	2	10	0	0	0
High/H	8	35.7	(3)	115	384	311	0	0
Medium-Low/ML	9	50.6 (4)	-	55	76	55	55	23
TOTAL RESIDENTIAL		1,872.9	10.0 (3)	2,600	2,600	2,059	708	440
OPEN SPACE/RECREATION:								
GOLF COURSE/G	10A	294.6	-	-	-	-	-	-
	10B	58.8	-	-	-	-	-	-
RECREATION/R:								
Buck Gully, Los Trancos/	11A	203.5	-	-	-	-	-	-
Muddy Canyons, Pelican/	11B	99.5	-	-	-	-	-	-
Wishbone Hill Areas	12A	606.0	-	-	-	-	-	-
	12B	56.0	-	-	-	-	-	-
	12C	98.0	-	-	-	-	-	-
	12D	32.7	-	-	-	-	-	-
	12E	274.0	-	-	-	-	-	-
El Moro Elementary School	12F	14.5	-	-	-	-	-	-
Moro Sliver	12G	35.0	-	-	-	-	-	-
	12H	37.5	-	-	-	-	-	-
	12I	19.6	-	-	-	-	-	-
Laguna Beach County Water District	12J	9.0	-	-	-	-	-	-
Crystal Cove State Park	17	2,807.0 (5)	-	-	-	-	-	-
Irvine Coast Wilderness	18	544.0 (6)	-	-	-	-	-	-
Regional Park (5)	19	133.0 (6)	-	-	-	-	-	-
Recreation Parcels Adjacent to Laguna Canyon Road	20B	12.0	-	-	-	-	-	-
	20C	8.0	-	-	-	-	-	-
CONSERVATION/C								
Conservation Parcels Adjacent to Laguna Canyon Road	16A	10.0	-	-	-	-	-	-
Irvine Coast Wilderness	16B	1.4	-	-	-	-	-	-
Regional Park (5)	21A/21B	1,989.0 (6)	-	-	-	-	-	-
	21C/21D							
TOTAL OPEN SPACE & RECREATION		7,343.1	0	0	0	0	0	0
TOURIST COMMERCIAL/TC								
	13A	6.2 (7)	46.4	770 (8)	1,100	770		
	13B	-	29.6	230 (8)	600	230		
	13C	5.6 (7)	31.4	450	750	450		
	13D	2.6 (7)	35.4	300	650	-		
	13E	46.0 (7)	13.4	150	300	-		
	13F	13.6 (7)	-	0	0	-		
	14	-	30.0	250	250	-		
	20A	-	17.4	0	0	-		
TOTAL COMMERCIAL		74.0 (7)	203.6	2,150	2,150	1,450	0	0
GRAND TOTAL		9,290.0	213.6 (3)	2,600/2,150	2,600/2,150	2,059/1,450	708	440

(1) Estimated number of dwelling units or accommodations per Planning Area.
 (2) Maximum number of dwelling units or accommodations per Planning Area.
 (3) A maximum of 10 gross acres (100,000 sq. ft.) of Neighborhood Commercial will be permitted in Medium/High Residential Planning Areas PA 1C, PA 2A, PA 2B, PA 3A, PA 3B or PA 8.
 (4) 27.4 acres of Residential Planning Area 9 is devoted to Golf Course.
 (5) Acreage includes the mobile home park.
 (6) Total area of Irvine Coast Wilderness Regional Park is 2,666 acres.
 (7) 74.0 acres within Tourist Commercial Planning Areas is devoted to Golf Course.
 (8) The equivalent of 1,000 resort accommodations have been approved in a Coastal Development Permit for the Disney Vacation Resort.

All Planning Areas which allow for residential uses shall be developed consistent with the maximum number of dwelling units indicated for the Planning Area in the PC Statistical Table. The PC Statistical Table shall be revised in accordance with the requirements contained in this Chapter. No amendment to the PC Zoning Map and/or PC District Regulations shall be required solely for the purpose of changing the number of dwelling units or acreage assigned to a Planning Area on the PC Statistical Table, provided the change is consistent with the PC Statistical Summary and the adopted PC Zoning Map, and that the maximum number of dwelling units permitted in The Newport Coast Planned Community shall not exceed 2,600 dwelling units. Compliance with the County's Housing Element will be demonstrated in the Housing Implementation Plan.

D. PROCEDURES FOR REVISIONS TO PC DEVELOPMENT MAP AND PC STATISTICAL TABLE

Revisions to the PC Development Map and Statistical Table shall be in accordance with the following procedures, which are intended to assure compliance with the goals and policies of the General Plan and the LCP Land Use Plan:

1. Any proposed revision to the PC Development Map and Statistical Table shall be accompanied by a project proposal consisting of a Coastal Development Permit, Site Plan, and/or Tentative Subdivision Map and shall require a public hearing before the Planning Commission.
2. Any revision to increase the number of estimated ("Est (a)") dwelling units or accommodations in any Planning Area shall be offset by a corresponding decrease in other Planning Area(s), provided that the total number of dwelling units and accommodations shown on the PC Development Map and Statistical Table for the entire Planned Community does not exceed 2,600 dwelling units and 2,150 accommodations, respectively; and the maximum ("Max (b)") dwelling units or accommodations shown on the Statistical Table for each Planning Area is not exceeded.
3. Any revision to reallocate the number of dwelling units, accommodations and/or the acreage assigned to land uses from one Planning Area to another Planning Area shall require an amendment to the PC Development Map and Statistical Table.

4. Any proposal to reallocate the number of dwelling units, accommodations, and/or the acreage assigned to land uses from one Planning Area to another Planning Area shall require submittal of the following information:
 - a. A revision to the PC Development Map showing all proposed changes to the PC Statistical Table;
 - b. An analysis of the consistency of the proposed changes with the LCP Land Use Plan and PC Zoning Map and Statistical Summary;
 - c. Identification on the PC Statistical Table of the number of units which have been approved on all Tentative Subdivision Maps and all recorded Final Subdivision Maps, and the dwelling units under construction or those completely constructed at the time of the proposed PC Statistical Table revision;
 - d. Identification of the ownership of parcels to be affected by the proposed PC Statistical Table revision; and
 - e. Any additional background and/or supporting information which the Director, Orange County EMA, deems necessary.
5. All Planning Area acreages identified on the PC Statistical Table may be revised by the Planning Commission when more accurate information is available.
6. All revisions to the PC Development Map and Statistical Table shall be consistent with the LCP Land Use Plan and the PC Zoning Map and Statistical Summary. The acreages listed in the Statistical Table for individual planning areas on the PC Development Map may be adjusted up to 10% without requiring an amendment to the LCP Land Use Plan. No revision shall be approved by this procedure which would have the effect of changing the land use category or development/open space boundaries shown on the PC Zoning Map and/or the LCP Land Use Plan.

CHAPTER 12

DEFINITIONS

The meaning and construction of words, phrases, titles, and terms used in this Newport Coast LCP shall be the same as provided in Section 7-9-21 of the County of Orange Zoning Code except as otherwise provided in this Chapter.

The words "Implementing Actions Program" and the initials "IAP" shall mean the Implementing Actions Program for The Newport Coast Planning Unit of the County's Local Coastal Program, certified by the California Coastal Commission.

The words "Land Use Plan" and the initials "LUP" shall mean the Land Use Plan for The Newport Coast Planning Unit of the County's Local Coastal Program, certified by the California Coastal Commission.

The word "used" includes the words "arranged for," "designed for," "occupied for", or "intended to be occupied for."

NOTE: Definitions following a single asterisk (*) are in addition to the definitions contained in the Zoning Code; those following a double asterisk (**) are different than the definitions contained in the Zoning Code.

***Appealable Area (See Exhibit Y "Appeal Jurisdiction"):**

- a. All area between the sea and the first public road paralleling the sea, or within 300 feet of the inland extent of any beach or the mean high tide line of the sea where there is no beach, whichever is the greater distance; and
- b. All area within 100 feet of any wetland, estuary, or stream and all area within 300 feet, both seaward and landward, of the top of the seaward face of any coastal bluff.

****Bedroom:** Any habitable room other than a bathroom, kitchen, dining room, living room, family room or den.



APPEAL JURISDICTION- Second Amendment

The Newport Coast Local Coastal Program

Exhibit Y

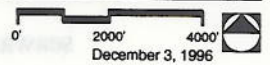

LEGEND

- LANDS WITHIN 100 FT. OF U.S.G.S. DRAINAGE COURSES
- LANDS BETWEEN THE SEA AND PACIFIC COAST HIGHWAY
- COASTAL ZONE BOUNDARY
- PLANNED COMMUNITY BOUNDARY
- PLANNING AREA BOUNDARY
- PLANNING AREA

****Building height:** Building height shall be measured along perpendiculars (plumb lines) from the elevation of the finished grade to the maximum height above grade specified in the development standards. Where the finished grade slopes at 10% or greater the maximum height above grade shall be as specified in the development standards plus ten (10) feet. These measurements shall be made consistent with the "Regional Interpretative Guidelines, South Coast Region, Orange County." Exhibit Z portrays the application of the height criteria. Maximum height shall be measured to the coping of a flat roof, or to the deck line of a mansard roof, or to the average height of the highest gable of a pitched or hipped roof. Elevators, mechanical space, chimneys and architectural treatments (intended to add interest and variation to roof design, yet which do not exceed 10% of the roof area, nor exceed the base-height restriction by more than 12 feet) will be permitted.

****Caretaker:** A person who lives on the premises for the necessary purposes of managing, operating, maintaining, or guarding the primary use or permitted uses on the premises. The term includes, but is not limited to, a gardener, maid, butler, guard, or other domestic or industrial/commercial custodian of the premises.

***Caretaker Quarters:** Living quarters, permitted in residential areas, for the housing of a caretaker(s) and the family of the caretaker who live in the same premises (not to exceed 1,500 square feet in floor area on building sites of a minimum 10,000 square feet). Caretaker quarters are not included within the category of, and are not counted toward, permitted dwelling units as specified in this LCP.

***Casitas:** Overnight/resort lodging consisting of multiple bedrooms that may be rented separately and which may or may not connect with a central living area which may include cooking facilities.

****Coastal Bluff:** Includes the following:

- a. Any bluff where the toe of the slope is now, or within the past 200 years has been, subject to marine erosion; and
- b. Any bluff where the toe of the slope is within 300 feet of the inland extent of any beach or the mean high tide line of the sea where there is no beach.

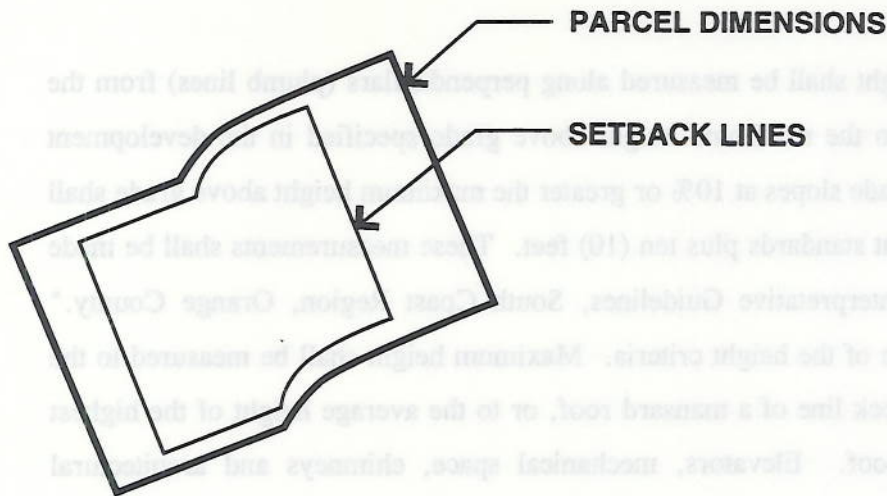

Figure 1
The sides of the envelope are established by the setback of the lot.

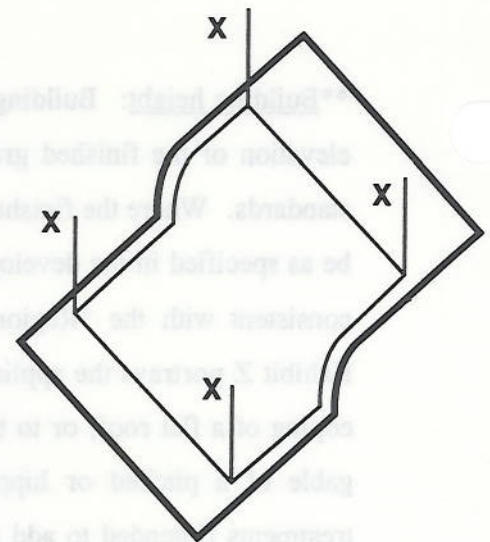

Figure 2
The elevation of any side surface is specified by the maximum guideline height. Height shall be measured along perpendiculars (plumb lines) from the grade elevation.

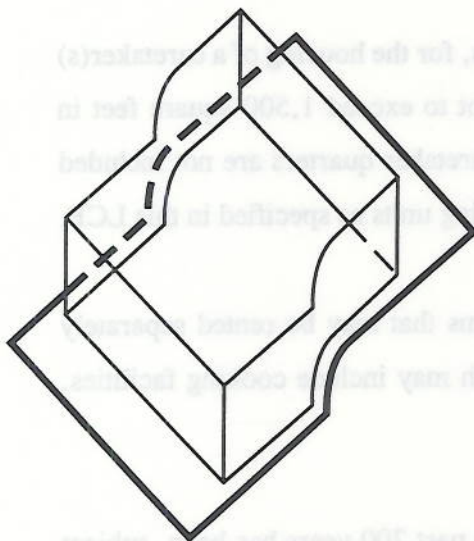

Figure 3
Side surfaces are established as the guideline height is applied to all points of each side.

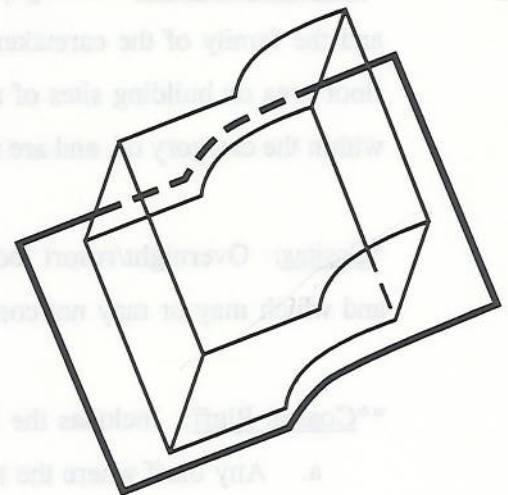

Figure 4
The upper surface of the envelope shall run parallel to the underlying grade elevation (contours) at the guideline specified height. In other words, the upper surface is that plane of points perpendicular to all points on the grade surface at the guideline specified height.

BUILDABLE ENVELOPE

The Newport Coast Local Coastal Program

***Community Information Center:** A temporary structure principally used as an information pavilion and/or office for the sale of homes in the community, and including parking and administrative facilities.

***Community Service Facility:** A for-profit commercial, or nonprofit use established primarily to service the immediate population of the community in which it is located.

***Conference Center Facility:** A facility, usually in conjunction with a hotel or other visitor accommodations, which offers facilities for business conferences and seminars, including, but not limited to, multi-purpose rooms serving as the main ballroom and prefunction space, smaller seminar rooms, large meeting rooms, audiovisual centers, etc.

***Destination Resort:** An integrated set of visitor-oriented uses with a variety of overnight/resort accommodations and diverse recreational opportunities including day-use commercial, restaurants, golf course(s), tennis complex(es), health spa(s) and other recreational amenities, conference and meeting facilities ancillary to overnight/resort accommodations, parking facilities, and other incidental and accessory uses supportive of and directly related to the resort. The destination resort will be designed to attract longer-term visitors as well as overnight guests. In order to provide a wide variety of options for visitors, overnight/resort accommodations may include individual hotel and motel rooms, casitas, multiple bedroom unit modules convertible to separate rooms or combined larger units, and individual time-share condominium units suitable for one or more families, all of which may include cooking facilities. Overnight/resort facilities may comprise hotels, individual units owned and/or managed by the hotel operators or owners and individually owned units. The destination resort facilities shall be advertised to the public as an integrated set of recreational visitor-serving attractions, with management of the overnight/resort accommodations structured to allow for both centralized (e.g., hotel) management and individual owner management.

****Duplex:** See Residential Duplex .

**** Dwelling Unit:** One or more rooms in a structure, including a kitchen, designed for occupancy by one family for living and sleeping purposes, and including a mobile home when such mobile home bears an insignia of approval issued by the California Department of Housing and Community

Development or a housing seal number from the Federal Department of Housing and Urban Development (HUD).

*Environmentally Sensitive Habitat Area (ESHA): A natural drainage course identified in LCP Land Use Plan Section I-2-A-2 and Exhibit H.

*Exterior Property Line: A property line abutting a public or private street.

**Floor Area, Gross: The total horizontal floor area of all floors of a building, including the exterior walls thereof, measured in square feet; excepting that for commercial, professional and administrative office or industrial buildings or building complexes, areas used in common such as, but not limited to, covered malls, covered walkways, hallways, mechanical equipment areas, stairwells, elevators, lobbies, roofed patio areas, covered entries, covered parking, covered driveways and covered loading areas shall not be included when calculating off-street parking requirements.

**Grade, Finished: The level of the ground surface surrounding a building.

*Gross Area: The entire land area within the boundary of a project, measured to the centerline of any abutting arterial highways.

*Gross Residential Density: The density of a residential project computed by dividing the total number of dwelling units in the project by the gross area of the project.

*Guest Cottage: A detached building, having no kitchen facilities, which is used primarily for sleeping purposes for members of the family occupying the main dwelling or their nonpaying guests (not to exceed 1,500 square feet in floor area.) Guest cottages are not included within the category of, and are not counted toward, permitted dwelling units as specified in this LCP.

**Hotel: Any building, portion thereof, or combination of buildings with access provided through a common entrance, lobby or hallway to guest rooms, with or without cooking facilities, and/or quarters, with or without cooking facilities, retail commercial and other ancillary facilities and which

rooms and quarters are designed, intended to be used or are used, rented or hired out as temporary or overnight accommodations for guests. (See also Destination Resort.)

*Interior Property Line: A property line which does not abut a private or public street.

*Joint Use of Parking: The shared use of off-street parking facilities by more than one type of land use. The same parking spaces are counted to satisfy the off-street parking requirements of more than one land use (e.g., use of the same parking facility to satisfy the off-street parking requirements of a church and an office building).

*Large-lot Subdivision: A Subdivision or Parcel Map, prepared for financing or conveyance purposes, where no parcel is smaller than 20 acres; and which includes a declaration that the lots created are not building sites. This may include Subdivisions or Parcel Maps for commercial or visitor-serving use areas.

**Motel: A building or group of buildings containing guest rooms or dwelling units designed, intended or used primarily for the accommodation of transient automobile travelers, including but not limited to buildings or building groups designated as auto cabins, motor courts or motor hotels.

*Net residential area: The area of land remaining in a project, measured in acres or square feet, after deduction of the area contained in streets (both public and private), schools, parks, flood control works and any other use, easement or incumbrance which prevents the surface use of the property for a building site or construction of structures.

*Net usable area (nonresidential): The area of land remaining in a project, measured in acres or square feet, after deduction of the area contained in public and private street and highway rights-of-way, schools, parks, flood control works and any other use, easement or encumbrance which limits the surface use of the property, slopes required to level the site, and required screening and landscaping. The area needed to satisfy the off-street parking requirements is included within the net usable acres.

*Overnight/resort accommodations: See Destination Resort.

***Regional Park Concession:** A use otherwise allowed in a regional park area which is operated by a limited commercial venture with the purpose of serving the recreational needs of park visitors and/or improving public recreation services either financially through lease or other payments to a public agency or functionally through the delivery of a permitted recreational use that otherwise would not be available to the public.

****Residential Duplex:** Refers to a residential development where two dwelling units are permitted on one building site. Residential duplex includes planned concept subdivisions and cluster developments; either as conventional subdivisions or planned developments.

****Residential Multiple-Family:** Refers to any residential development wherein the minimum number of permitted dwelling units on one building site is three (3) or more. Multiple-family residential includes multiple-family dwellings, apartments, condominiums, and stock cooperative projects.

****Residential Single-Family:** Refers to any residential development wherein each dwelling unit is situated on a residential lot of record and no lot contains more than one dwelling unit and, where permitted, a caretaker's or employee's quarters. Single-family residential includes attached and detached single-family dwellings, planned concept subdivisions, cluster developments, either as conventional subdivisions or planned developments.

***Restaurant:** An establishment where foods and beverages are prepared and/or dispensed for consumption on or off site. Restaurants include but may not be limited to fully enclosed establishments, partially enclosed establishments, drive-ins, drive-throughs, and fast food establishments.

***Story:** That portion of a building included between the upper surface of any floor and the upper surface of the floor next above, except that the topmost story shall be that portion of a building included between the upper surface of the topmost floor and the ceiling or roof above.

13. Legal Description

CHAPTER 13
LEGAL DESCRIPTION

FOR THE SECOND AMENDMENT
TO THE NEWPORT COAST PLANNED COMMUNITY

THOSE PORTIONS OF BLOCKS 95, 97, 128 THROUGH 134, 161 THROUGH 167, 180 THROUGH 183 AND 185, IRVINE'S SUBDIVISION, IN THE COUNTY OF ORANGE, STATE OF CALIFORNIA, AS PER MAP FILED IN BOOK 1, PAGE 88, MISCELLANEOUS RECORD MAPS, RECORDS OF SAID COUNTY, DESCRIBED AS FOLLOWS:

PARCEL 1:

Beginning at the most Southerly corner of the "Cameo Highland Annex" to the City of Newport Beach, said corner being the Northeast right-of-way line of Pacific Coast Highway as described in a deed to the State of California recorded May 20, 1931 in Book 487, page 1, Official Records of said County; thence along the boundary of said City of Newport Beach the following described courses:

1. N. 40° 30' 20" E., 364.00 feet;
2. N. 26° 47' 20" E., 465.00 feet;
3. N. 2° 12' 20" E., 387.00 feet;
4. N. 85° 00' 40" W., 190.00 feet;
5. N. 71° 34' 40" W., 174.00 feet;
6. N. 56° 17' 40" W., 53.96 feet;
7. N. 18° 25' 20" E., 109.15 feet;
8. N. 49° 27' 44" W., 225.00 feet;
9. S. 33° 42' 20" W., 132.05 feet;
10. N. 56° 17' 40" W., 340.87 feet;
11. N. 59° 47' 40" W., 410.00 feet;
12. N. 70° 35' 10" W., 271.93 feet;
13. N. 24° 45' 00" W., 239.20 feet;

14. N. 12° 45' 00" W., 194.77 feet;
15. N. 22° 15' 00" W., 406.53 feet;
16. N. 0° 45' 00" E., 365.18 feet;
17. N. 06° 52' 40" E., 0.76 feet;
18. N. 64° 14' 17" W., 301.15 feet;
19. S. 71° 33' 38" W., 315.61 feet;
20. N. 78° 08' 54" W., 318.10 feet;
21. N. 07° 09' 36" E., 64.02 feet;
22. N. 24° 58' 36" E., 63.02 feet;
23. N. 64° 29' 06" E., 50.07 feet;
24. N. 77° 02' 06" E., 151.63 feet;
25. N. 44° 39' 56" E., 103.18 feet;
26. S. 72° 11' 37" E., 147.46 feet;
27. N. 02° 50' 38" E., 166.07 feet;
28. N. 46° 00' 28" E., 114.21 feet;
29. S. 69° 47' 07" E., 145.87 feet;
30. N. 60° 27' 58" E., 156.35 feet;
31. S. 27° 34' 37" E., 131.08 feet;
32. N. 89° 57' 20" E., 732.55 feet;
33. N. 40° 57' 20" E., 1,320.00 feet;
34. N. 24° 57' 20" E., 1,680.00 feet;
35. S. 89° 02' 40" E., 1,050.00 feet;
36. N. 07° 57' 20" E., 852.95 feet;
37. Leaving said boundary, S. 73° 59' 15" E., 2,559.23 Feet;
38. S. 89° 59' 45" E., 679.33 feet;
39. N. 63° 01' 07" E., 190.96 feet;
40. S. 86° 27' 21" E., 465.31 feet;
41. N. 79° 17' 39" E., 1036.87 feet;
42. N. 87° 09' 43" E., 1338.73 feet;
43. N. 76° 05' 30" E., 328.20 feet;
44. N. 57° 17' 54" E., 446.57 feet;
45. N. 65° 01' 42" E., 434.01 feet;

46. N. 86° 59' 37" E., 553.17 feet;
47. N. 88° 54' 48" E., 863.22 feet;
48. S. 76° 08' 53" E., 668.82 feet;
49. S. 78° 53' 11" E., 404.48 feet;
50. S. 88° 34' 10" E., 1138.42 feet;
51. S. 81° 27' 33" E., 968.88 feet;
52. S. 89° 21' 53" E., 1984.12 feet;
53. N. 89° 07' 46" E., 1316.15 feet;
54. S. 71° 07' 11" E., 244.14 feet;
55. S. 46° 31' 00" E., 848.19 feet;
56. S. 41° 41' 40" E., 538.97 feet;
57. S. 22° 14' 31" E., 315.36 feet;
58. S. 38° 33' 52" E., 489.32 feet;
59. S. 24° 22' 42" E., 331.27 feet;
60. S. 12° 44' 41" W., 337.73 feet;
61. S. 34° 26' 47" E., 410.92 feet;
62. S. 54° 32' 56" E., 526.14 feet;
63. S. 39° 06' 59" E., 465.65 feet;
64. S. 66° 44' 19" E., 658.40 feet;
65. N. 83° 28' 38" E., 326.82 feet;
66. S. 60° 08' 12" E., 785.39 feet;
67. S. 68° 21' 36" E., 560.20 feet;
68. S. 34° 56' 14" E., 457.86 feet;
69. S. 24° 59' 11" E., 227.27 feet;
70. S. 62° 51' 54" E., 1752.88 feet;
71. S. 64° 52' 34" E., 1493.44 feet;
72. S. 60° 59' 36" E., 540.25 feet;
73. S. 49° 25' 35" E., 871.18 feet;
74. S. 66° 26' 24" E., 84.08 feet;
75. S. 64° 24' 04" E., 711.68 feet;
76. S. 60° 00' 22" E., 513.59 feet;
77. S. 60° 24' 52" E., 1287.83 feet to a point in the boundary of the City of Laguna Beach, said point being on a curve concave Easterly, having a radius of 425.00

- feet, a radial to said curve bears S. 89° 29' 46" W.; thence along last said boundary;
78. Southerly, 47.30 feet along said curve, through a central angle of 6° 22' 38";
 79. S. 6° 52' 52" E., 264.82 feet;
 80. S. 83° 11' 34" W., 228.16 feet;
 81. S. 6° 48' 26" E., 443.29 feet to a curve concave Westerly, having a radius of 345.00 feet;
 82. Southerly, 149.93 feet along said curve, through a central angle of 24° 54' 00";
 83. S. 18° 05' 34" W., 323.31 feet to a curve concave Easterly, having a radius of 1255.00 feet;
 84. Southerly, 142.19 feet along said curve, through a central angle of 6° 29' 30";
 85. S. 11° 36' 4" W., 909.28 feet;
 86. S. 11° 17' 49" W., 1113.97 feet;
 87. S. 12° 52' 49" W., 385.94 feet to a curve concave Easterly, having a radius of 655.00 feet;
 88. Southerly, 258.36 feet along said curve, through a central angle of 22° 36' 00";
 89. S. 9° 43' 11" E., 462.58 feet to a curve concave Westerly, having a radius of 145.00 feet;
 90. Southerly, 47.78 feet along said curve, through a central angle of 18° 52' 45";
 91. S. 9° 09' 34" W., 1981.77 feet to a curve concave Easterly, having a radius of 1255.00 feet;
 92. Southerly, 255.54 feet along said curve, through a central angle of 11° 40' 00";
 93. S. 2° 30' 26" E., 532.31 feet to a curve concave Northwesterly, having a radius of 195.00 feet;
 94. Southwesterly, 261.21 feet along said curve, through a central angle of 76° 45' 00";
 95. S. 74° 14' 34" W., 215.79 feet to a curve concave Northerly, having a radius of 195.00 feet;
 96. Westerly, 132.05 feet along said curve, through a central angle of 38° 48' 00";
 97. N. 66° 57' 26" W., 248.29 feet to a curve concave Southerly, having a radius of 1155.00 feet;
 98. Westerly, 715.71 feet along said curve, through a central angle of 35° 30' 15";
 99. S. 77° 32' 19" W., 198.05 feet to a curve concave Southeasterly, having a radius of 555.00 feet;
 100. Southwesterly, 227.88 feet along said curve, through a central angle of 23° 31' 30";

101. S. 54° 00' 49" W., 350.12 feet to a curve concave Southeasterly, having a radius of 555.00 feet;
102. Southwesterly, 212.42 feet along said curve, through a central angle of 21° 55' 45";
103. S. 32° 05' 04" W., 238.45 feet;
104. N. 57° 54' 56" W., 85.00 feet;
105. S. 32° 05' 04" W., 400.00 feet;
106. S. 57° 54' 56" E., 85.00 feet;
107. S. 32° 05' 04" W., 274.68 feet;
108. S. 57° 54' 56" E., 230.00 feet;
109. S. 32° 05' 04" W., 346.27 feet to a curve concave Easterly, having a radius of 925.00 feet;
110. Southerly, 374.73 feet along said curve, through a central angle of 23° 12' 41";
111. S. 8° 52' 23" W., 583.75 feet to a curve concave Westerly, having a radius of 875.00 feet;
112. Southerly, 184.42 feet along said curve, through a central angle of 12° 04' 34";
113. S. 20° 56' 57" W., 68.73 feet;
114. N. 69° 03' 03" W., 60.00 feet;
115. S. 20° 56' 57" W., 300.28 feet to a curve concave Northwesterly, having a radius of 2945.00 feet;
116. Southwesterly, 20.00 feet along said curve, through a central angle of 0° 23' 21";
117. N. 68° 39' 42" W., 70.00 feet radial to said curve;
118. S. 35° 58' 04" W., 129.75 feet;
119. S. 66° 07' 57" E., 100.00 feet radial to last said curve, to the Southwesterly prolongation of said curve;
120. Southwesterly, 144.78 feet along last said curve, through a central angle of 2° 49' 00";
121. S. 37° 58' 01" W., 681.41 feet;
122. S. 39° 22' 40" W., 384.76 feet;
123. S. 47° 37' 27" W., 803.58 feet;
124. S. 55° 35' 41" W., 252.44 feet;
125. S. 42° 47' 6" W., 395.44 feet;
126. S. 36° 16' 46" W., 395.53 feet;
127. N. 59° 13' 57" W., 90.00 feet to a curve concave Southerly, having a radius of 120.00 feet;

128. Westerly, 83.78 feet along said curve, through a central angle of 40° 00' 00";
129. S. 80° 46' 03" W., 106.00 feet to a curve concave Southeasterly, having a radius of 105.00 feet;
130. Southwesterly, 48.87 feet along said curve, through a central angle of 26° 40' 00" to a reverse curve concave Northwesterly, having a radius of 110.00 feet;
131. Northwesterly, 255.16 feet along said curve, through a central angle of 132° 54' 19";
132. Non-tangent to said curve, N., 12° 52' 23" E., 523.10 feet;
133. N. 0° 05' 03" E., 243.70 feet;
134. N. 25° 54' 57" W., 540.93 feet;
135. S. 56° 05' 03" W., 295.13 feet;
136. S. 89° 03' 33" W., 246.11 feet;
137. S. 0° 31' 43" W., 160.00 feet;
138. S. 68° 01' 27" E., 320.35 feet;
139. S. 5° 53' 57" E., 222.62 feet;
140. S. 27° 57' 43" W., 515.46 feet;
141. N. 49° 32' 17" W., 198.04 feet;
142. S. 40° 31' 43" W., 543.84 feet;
143. N. 56° 21' 01" W., 148.13 feet;
144. N. 49° 28' 17" W., 265.40 feet;
145. S. 81° 20' 43" W., 131.76 feet;
146. N. 49° 28' 17" W., 1480.30 feet;
147. S. 40° 46' 43" W., 1180.11 feet;
148. N. 53° 23' 21" W., 22.86 feet;
149. N. 67° 03' 17" W., 36.00 feet to a point of cusp with a curve concave Northwesterly, having a radius of 179.88 feet, a radial to said curve bears S. 67° 03' 17" E;
150. Southwesterly, 57.32 feet along said curve, through a central angle of 18° 15' 33" to the beginning of a non-tangent curve concave Southeasterly, having a radius of 30.00 feet, a radial to said curve bears N. 29° 50' 31" E;
151. Southwesterly, 73.84 feet along said curve, through a central angle of 141° 01' 29" to the beginning of a reverse curve concave Westerly, having a radius of 15.00 feet;
152. Southerly, 16.66 feet along said curve, through a central angle of 63° 38' 11" to the Southwest line of said Block 183;

153. Along said Southwest line and said boundary of the City of Laguna Beach, N. 49° 28' 17" W., 551.10 feet;
154. Leaving said Southwest Block line, N. 24° 51' 03" W., 79.61 feet;
155. N. 0° 55' 17" W., 40.00 feet;
156. S. 89° 04' 43" W., 95.39 feet to said Southwest Block line;
157. Along said Southwest line, N. 49° 28' 17" W., 2133.40 feet to the West corner of said Block 183.
158. Leaving said City boundary, N. 49° 28' 13" W., 2597.84 feet along the Northeast line of said Block 164, being in part the Northeast line of Tract No. 3125 as per map filed in Book 98, pages 9 through 11, inclusive of Miscellaneous Maps, in the office of the County Recorder of said County, to the most Northerly corner of said Tract;
159. Along the Northwest line of said Tract, S. 40° 30' 55" W., 1167.32 feet, to an angle point in the boundary of the "Cameo Cove Annexation" to the City of Laguna Beach;
160. Along said boundary, N. 53° 23' 40" W., 672.23 feet;
161. N. 62° 03' 40" W., 1009.13 feet;
162. S. 27° 56' 20" W., 700.00 feet, to the Northeasterly right-of-way line of said Pacific Coast Highway;
163. Leaving said boundary, traversing along said right-of-way line, N. 62° 03' 40" W., 88.01 feet to a curve concave Northeasterly, having a radius of 1450.00 feet;
164. Northwesterly, 612.86 feet along said curve, through a central angle of 24° 13' 00";
165. N. 37° 50' 40" W., 445.69 feet to a curve concave Southwesterly, having a radius of 2050.00 feet;
166. Northwesterly, 374.79 feet along said curve, through a central angle of 10° 28' 30";
167. N. 48° 19' 10" W., 1097.18 feet to a curve concave Northeasterly, having a radius of 1450.00 feet;
168. Northwesterly, 383.83 feet along said curve, through a central angle of 15° 10' 00";
169. N. 33° 09' 10" W., 119.30 feet to a curve concave Southwesterly, having a radius of 1550.00 feet;
170. Northwesterly, 518.96 feet along said curve, through a central angle of 19° 11' 00";
171. N. 52° 20' 10" W., 2498.67 feet to a curve concave Northeasterly, having a radius of 4950.00 feet;
172. Northwesterly, 679.63 feet along said curve, through a central angle of 7° 52' 00";

- 173. N. 44° 28' 10" W., 1966.20 feet to a curve concave Northeasterly, having a radius of 1950.00 feet;
- 174. Northwesterly, 856.24 feet along said curve, through a central angle of 25° 09' 30";
- 175. N. 19° 18' 40" W., 399.81 feet to a curve concave Southwesterly, having a radius of 2050.00 feet;
- 176. Northwesterly, 1079.94 feet along said curve, through a central angle of 30° 11' 00";
- 177. N. 49° 29' 40" W., 5467.56 feet to the point of beginning.

Containing 9156.1 acres, more or less.

PARCEL 2:

Those portions of said Blocks 131 and 164 lying Southwesterly of the Pacific Coast Highway 100.00 feet wide, as described in a deed to the State of California, recorded May 20, 1931 in Book 487, Page 1, said Official Records, and being bounded on the Southwest by the line of Ordinary High Tide of the Pacific Ocean, on the Southeast by the Northwesterly boundary of the land described in a deed to the Irvine Cove Community Association recorded July 5, 1974 in Book 11189, Page 1323 of Official Records of said County and the Northerly line of Tract 4655, per the map filed in Book 192, Pages 1 through 3, inclusive, of Miscellaneous Maps, records of said County, and on the Northwesterly by the Northwest line of said Block 131, said Parcel being more particularly described by the following two (2) Parcels:

PARCEL 2A

Being all of that Parcel shown within the distinctive border line on the map of Tract No. 14063, filed in book 670, pages 23 through 29, inclusive, of Miscellaneous Maps, records of said County, and more particularly described as follows:

Beginning at the most Northerly corner of said Tract No. 14063, on said Southwesterly line, Pacific Coast Highway;

Thence, along said Southwesterly line, the following three (3) courses:

1. S. 57° 39' 44" E., 14.43 feet to the beginning of a curve concave Southwesterly, having a radius of 1950.00 feet;
2. Southeasterly, 277.98 feet along said curve, through a central angle of 08° 10' 04", and;
3. S. 49° 29' 40" E., 800.00 feet;

Thence, leaving said southwesterly line and continuing along said distinctive border line, the following sixteen (16) courses:

1. S. 40° 30' 20" W., 722.85 feet;
2. S. 15° 09' 40" W., 320.64 feet;
3. S. 39° 40' 04" W., 617.07 feet;
4. N. 51° 31' 11" W., 9.73 feet;
5. S. 61° 06' 48" W., 59.78 feet;
6. N. 74° 29' 51" W., 156.61 feet;
7. N. 55° 14' 39" W., 73.02 feet;
8. N. 15° 04' 06" W., 75.69 feet;
9. N. 74° 21' 28" W., 56.34 feet;
10. S. 73° 01' 02" W., 64.35 feet;
11. N. 63° 26' 06" W., 168.74 feet;
12. N. 81° 09' 29" W., 121.10 feet;
13. S. 85° 25' 34" W., 176.97 feet;
14. N. 34° 18' 12" W., 165.76 feet;
15. N. 65° 52' 44" W., 63.74 feet, and;
16. N. 77° 46' 30" W., 264.79 feet to the Northwesterly line of said Block 131, as shown on the Map of Record of Survey 83-1105, filed in Book 108, pages 37 through 40, inclusive, of Records of Survey, records of said County;

Thence, along said Northwesterly line, N. 40° 33' 07" E., 2102.29 feet to the point of beginning.

Containing, 50.56 acres, more or less.

PARCEL 2B

Beginning at the intersection of the line of ordinary high tide with the Northerly line of Tract No. 4655 as shown on the map filed in Book 192, pages 1 through 3, inclusive, of Miscellaneous Maps, of said records;

Thence, along said Northerly line of said Tract No. 4655, the following eight (8) courses:

1. S. 75° 08' 40" E., 45.00 feet;
2. N. 70° 51' 20" E., 30.00 feet;
3. S. 73° 08' 40" E., 30.00 feet;
4. S. 46° 38' 40" E., 60.00 feet;
5. S. 66° 53' 40" E., 50.00 feet;
6. N. 88° 06' 20" E., 35.00 feet;
7. N. 60° 15' 00" E., 20.00 feet, and;
8. S. 86° 18' 40" E., 40.00 feet to an angle point in the Northwesterly line of the land described in said deed to the Irvine Cove Community Association.

Thence, along said Northwesterly line, the following two (2) courses:

1. N. 57° 37' 00" E., 262.64 feet, and;
2. N. 76° 31' 20" E., 236.91 feet to a point of cusp on a non-tangent curve concave Northeasterly, and being on the said Southwesterly line of the Pacific Coast Highway, having a radius of 1,550.00 feet, a radial line through said point bears S. 32° 52' 05" W.;

Thence, traversing along the said Southwesterly line, Pacific Coast Highway, the following fourteen (14) courses:

1. Northeasterly, 521.78 feet along said curve, through a central angle of 19° 17' 15";
2. N. 37° 50' 40" W., 445.69 feet to the beginning of a curve concave Southwesterly, having a radius of 1,950.00 feet;
3. Northwesterly, 356.51 feet along said curve, through a central angle of 10° 28' 30";

4. N. 48° 19' 10" W., 1,097.18 feet to the beginning of a curve concave Northeasterly, having a radius of 1,550.00 feet;
5. Northwesterly, 410.30 feet along said curve, through a central angle of 15° 10' 00";
6. N. 33° 09' 10" W., 119.30 feet to the beginning of a curve concave Southwesterly, having a radius of 1,450.00 feet;
7. Northwesterly, 485.48 feet along said curve, through a central angle of 19° 11' 00";
8. N. 52° 20' 10" W., 2,498.67 feet to the beginning of a curve concave Northeasterly, having a radius of 5,050.00 feet;
9. Northwesterly, 693.36 feet along said curve, through a central angle of 07° 52' 00";
10. N. 44° 28' 10" W., 1,966.20 feet to the beginning of a curve concave Northeasterly, having a radius of 2,050.00 feet;
11. Northwesterly, 900.15 feet along said curve, through a central angle of 25° 09' 30";
12. N. 19° 18' 40" W., 399.81 feet to the beginning of a curve concave Southwesterly, having a radius of 1,950.00 feet;
13. Northwesterly, 1,027.26 feet along said curve, through a central angle of 30° 11' 00", and;
14. N. 49° 29' 40" W., 4,997.56 feet to the most Easterly corner of said Tract No. 14063, on said Northwesterly line, Pacific Coast Highway.

Thence, leaving said Southwesterly line and traversing along the Southeasterly and Southwesterly lines of said Tract No. 14063, the following sixteen (16) courses:

1. S. 40° 30' 20" W., 722.85 feet;
2. S. 15° 09' 40" W., 320.64 feet;
3. S. 39° 40' 04" W., 617.07 feet;
4. N. 51° 31' 11" W., 9.73 feet;
5. S. 61° 06' 48" W., 59.78 feet;
6. N. 74° 29' 51" W., 156.61 feet;
7. N. 55° 14' 39" W., 73.02 feet;
8. N. 15° 04' 06" W., 75.69 feet;
9. N. 74° 21' 28" W., 56.34 feet;
10. S. 73° 02' 02" W., 64.35 feet;

11. N. 63° 26' 06" W., 168.74 feet;
12. N. 81° 09' 29" W., 121.10 feet;
13. S. 85° 25' 34" W., 176.97 feet;
14. N. 34° 18' 12" W., 165.76 feet;
15. N. 65° 52' 44" W., 63.74 feet, and;
16. N. 77° 46' 30" W., 264.79 feet to the Northwesterly line of said Block 131, as shown on said Map of Record of Survey 83-1105.

Thence, along said Northwesterly line, Block 131, S. 40° 33' 07" W., 100.00 feet to the line of ordinary high tide;

Thence, along said ordinary high tide to the point of beginning.

Containing, 287 acres, more or less.

This description is prepared for agreement purposes only and may not be used for or in documents for, the conveyance of land.



Eugene A. Shaffer
 Eugene A. Shaffer, L.S. 4644

My License Expires September 30, 1998

January 19, 1995

Revised September 27, 1995

Revised November 15, 1995

Revised January 25, 1996

Revised October 29, 1996

11887.02 (003)

LUP Map Pocket

APPENDIX II

(Technical Documents Bound under Separate Cover)

A. Actions/Agency Reports

1. Orange County Board of Supervisors Hearing — June 18, 1996
 - a. Minutes
 - b. Agenda Item Transmittal
2. Orange County Board of Supervisors Hearing — July 16, 1996
 - a. Minutes
 - b. Supplemental Agenda Item Transmittal
 - c. Adopted Resolution No. 96-529
3. California Coastal Commission Hearing — October 10, 1996
 - a. Staff Report
 - b. Approval Letter to Orange County EMA — October 23, 1996
 - c. Certification Letter to Orange County Board of Supervisors
4. Orange County Board of Supervisors Hearing — November 19, 1996
 - a. Minutes
 - b. Agenda Item Transmittal
 - c. Adopted Resolution No. 96-861
 - d. Ordinance No. 96-3974
 - e. Ordinance No. 96-3975

B. Orange County Master Plan of Arterial Highways Amendment No. T95-1

1. Board of Supervisors Resolution No. 95-561
2. Environmental Management Agency Report
3. Master Plan of Arterial Highways (MPAH) Amendment Traffic Study (June, 1995)

C. School Impact Analysis**D. Relationship of the Proposed Irvine Coast LCP — Second Amendment to the NCCP Subregional Plan****E. Newport Coast LCP — Second Amendment Overview**